

# GENERAL CATALOG

G-103 updated 02/2014



 **victaulic®**

---

WHERE  
INNOVATION  
AND SOLUTIONS  
ARE JOINED  
TOGETHER



Since the first patent in 1919, Victaulic® has delivered innovative pipe joining solutions that help customers succeed worldwide. Look inside many of the world's most recognizable landmarks and industrial facilities, and you'll find Victaulic® solutions at work making bold design innovations possible, speeding time to completion, allowing for unpredictable seismic movements and setting the stage for scalability.

Today, Victaulic® supports its customers with manufacturing facilities and branches located around the globe including our world headquarters location in Easton, Pennsylvania, USA. Our international presence ensures that our worldwide customers are served with speed and efficiency.

As the world's leading producer of grooved mechanical pipe joining systems, Victaulic® has been delivering global innovative solutions across diverse business lines including building services, clean water and wastewater, fire protection, industrial construction, maritime, mining, oil, gas and chemical, power generation as well as custom castings.

From concept to commissioning, Victaulic® provides the technologies and services necessary to simplify your next project.

## TABLE OF CONTENTS

ii	The Victaulic® Difference
1	Original Groove System (OGS)
23	Advanced Groove System (AGS)
31	Victaulic® Bolted Split-Sleeve Products (VBSP)
33	Hole Cut System
35	Expansion Joints
41	Plain End System for Carbon Steel
43	Stainless Steel System
53	Copper System
57	AWWA System
63	Hydronic Balancing Solutions
77	HDPE System
79	Aquamine® PVC System
83	Grooved PVC System
84	FRP System
85	Pipe Preparation Tools
115	Gaskets/Seals/O-Rings
121	Design Data
125	Index



# THE VICTAULIC® DIFFERENCE

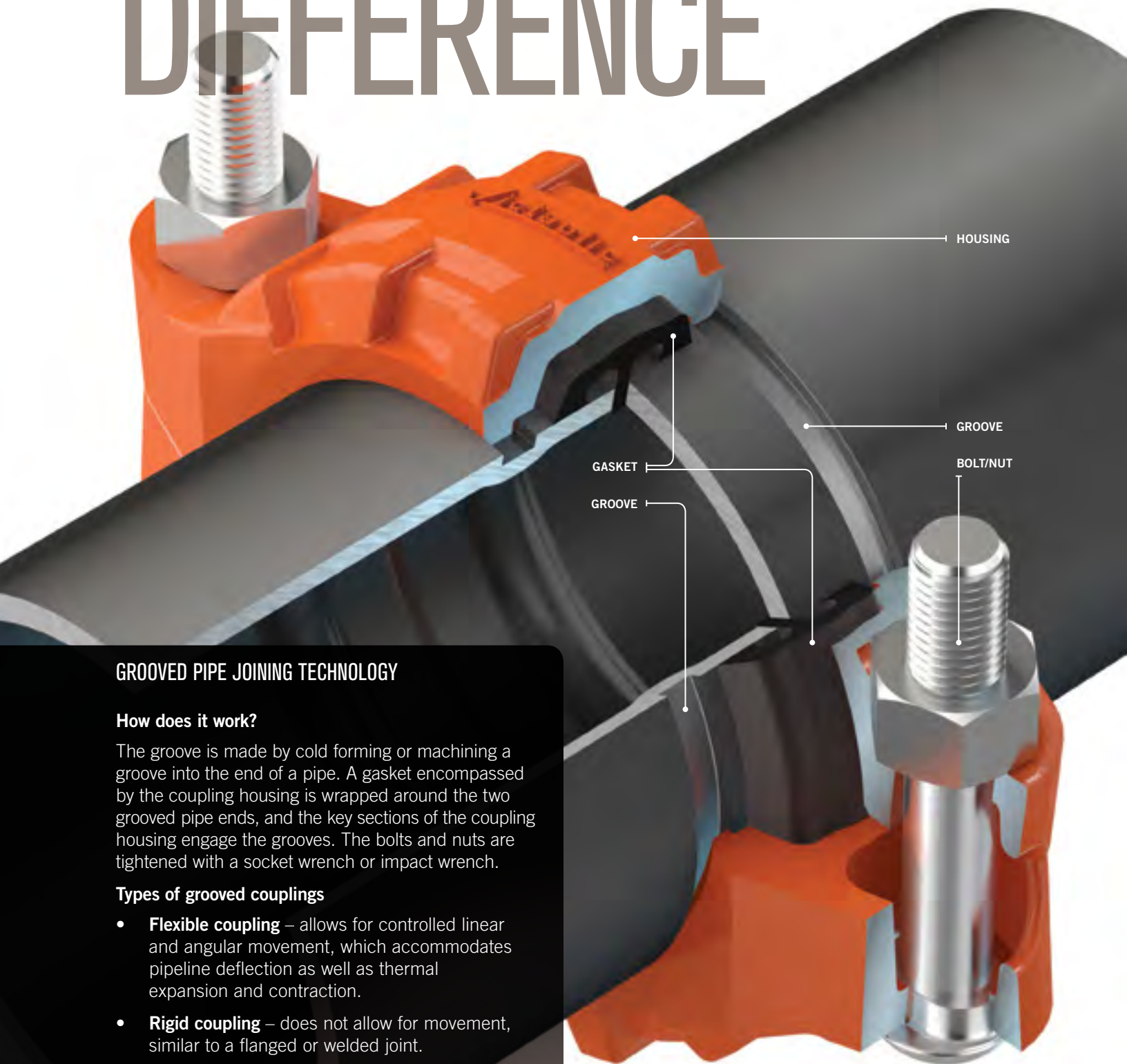

## GROOVED PIPE JOINING TECHNOLOGY

### How does it work?

The groove is made by cold forming or machining a groove into the end of a pipe. A gasket encompassed by the coupling housing is wrapped around the two grooved pipe ends, and the key sections of the coupling housing engage the grooves. The bolts and nuts are tightened with a socket wrench or impact wrench.

### Types of grooved couplings

- **Flexible coupling** – allows for controlled linear and angular movement, which accommodates pipeline deflection as well as thermal expansion and contraction.
- **Rigid coupling** – does not allow for movement, similar to a flanged or welded joint.



At the core of all the benefits that Victaulic® solutions bring to a project – such as productivity, safety, design flexibility and quality – are the unique features of our products.

**VICTAULIC® GROOVED END PIPING SYSTEMS PROVIDE:**



**Easy system maintenance and expansion** – through simple coupling disassembly that allows for easy access.



**Alignment ease** – through a design that allows for full rotation of the pipe and system components before tightening.

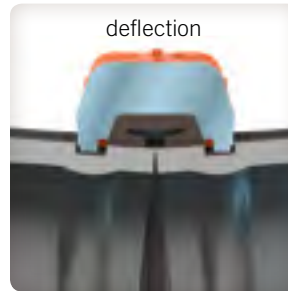
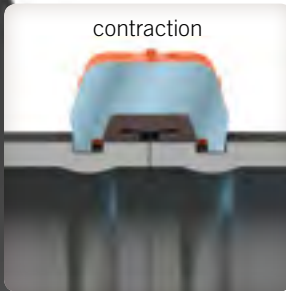

**Flexibility** – with the inherent axial movement and deflection properties of flexible couplings in a groove system. May be used to accommodate pipeline thermal expansion and contraction, misalignment and settlement, and seismic stress absorption.

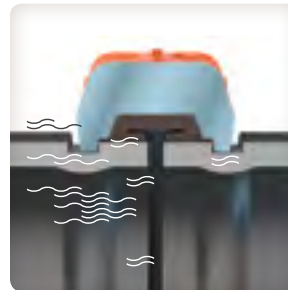

**Noise and vibration attenuation** – by isolating the transference of vibration at each joint.

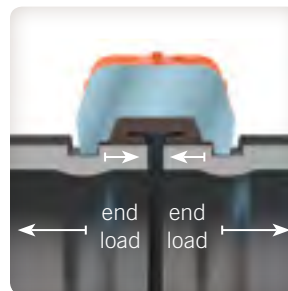

**Self restrained pipe joints** – Couplings engage the pipe grooves to hold the pipes against full pressure thrust loads without the need of supplemental restraints.



**Rigidity** – with an angled pad design that provides positive clamping of the pipe to resist torsional and flexural loads.





















## Original Groove System (OGS)

The Victaulic® grooved piping system is the most versatile, economical, and reliable piping system available. It is up to three times faster to install than welding, easier and more reliable than threading or flanging, resulting in lower total installed cost. The system is designed for roll grooved or cut grooved standard pipe or roll grooved light wall pipe. Also, pipe end preparation is fast and easy. It can be done on the job site or in the shop with a variety of Victaulic® grooving tools.



With the introduction of Victaulic® Installation-Ready™ technology, the original groove system has evolved to a new level. Grooved couplings featuring this patented Victaulic® technology install ten times faster than other pipe joining methods. Why is it different? Prior to Victaulic® Installation-Ready™ technology, grooved coupling assembly

consisted of disassembling the coupling by removing the bolts and nuts, removing the gasket, fitting the gasket over the gap between two grooved pipe ends, wrapping the housings around the gasket and then tightening down the bolts and nuts. Couplings featuring Installation-Ready™ technology come pre-assembled and are simply pushed onto a grooved pipe end, joined by a second grooved pipe end, and then bolts and nuts are tightened down. What previously required minutes, now takes only seconds.



<b>Couplings</b>	<b>page</b>	<b>Adapters</b>	<b>page</b>
 QuickVic® Rigid Coupling (Style 107)	3	 Vic-Flange® Adapter (Style 741)	8
 QuickVic® Flexible Coupling (Style 177)	3	 Vic-Flange® Adapter (Style 743)	8
 Composite Flexible Coupling (Style 171)	3		
 Zero-Flex® Rigid Coupling (Style 07)	4	<b>Fittings</b>	<b>page</b>
 Flexible Coupling (Style 77)	4	 Elbows	9
 Flexible Coupling (Style 75)	4	 Tees, Crosses, Wyes and Laterals	10
 Reducing Coupling (Style 750)	5	 Adapters, Nipples, Caps and Plugs	11
 Snap-Joint® Coupling (Style 78)	5	 Reducers	12
 Outlet Coupling (Style 72)	5	 XL Fittings for use with XL Couplings	12
 Vic-Boltless® Coupling and Tool (Styles 791 and 792)	6	<b>Expansion Joints</b>	<b>page</b>
 High Pressure Rigid Coupling (Style HP-70)	6	 Mover® Expansion Joint (Style 150)	13
 XL Couplings for use with XL Fittings (Style XL77 and XL79)	6	 Expansion Joint (Style 155)	13

## Vic-Ring® Couplings









 Vic-Ring® Coupling (Style 41)	7
 Vic-Ring® Coupling (Style 44)	7

For information on product compliance with NSF 372 please visit [victaulic.com/low-lead](http://victaulic.com/low-lead)







**Valves**

	Vic-300® MasterSeal™ Butterfly Valve (Series 761)	14
	Butterfly Valve (Series 700)	14
	Vic-Check® Valve (Series 716H and 716)	15
	Venturi Check Valve (Series 779)	15
	Swinger® Swing Check Valve (Series 712 and 713)	16
	Diverter Valve (Series 725)	16
	Vic®-Ball Valve (Series 721 and 726)	17
	Ball Valve (Series 727)	17
	Brass-body Ball Valve, Threaded (Series 722)	18
	Three Port Diverter (Series 723)	18
	Vic-Plug® Valve (Series 377)	18
	MTS Plug Valve (Series 465)	19
	Triple Service (Duty) Assemblies (Butterfly/Check)	19
	Triple Service (Duty) Assemblies (Plug/Check)	19





**page**

**Strainers and Diffusers**

	Suction Diffuser (Series 731-D)	20
	Vic-Strainer® Tee Type (Series 730)	20
	Vic-Strainer® Wye Type (Series 732)	20

**page**

**Specialty Products**

	EndSeal® System	21
	High Pressure Coupling (Style 808)	21
	XL (Extended Life) System for Rubber-lined Abrasive Services	22
	Mechanical-T® Spigot Assembly (Style 926)	22

**page**



## Original Groove System (OGS)

INSTALLATION-  
READY™



## QuickVic® Rigid Coupling

STYLE 107

[Download submittal 06.21](#) for complete information

- Angled bolt pad provides rigidity
- Sizes from 2–12" | 50–300 mm
- Pressures up to 750 psi | 5175 kPa
- For coating options, download product submittal

### Approvals/Listings:



INSTALLATION-  
READY™



## QuickVic® Flexible Coupling

STYLE 177

[Download submittal 06.20](#) for complete information

- Sizes from 2–8" | 50–200 mm
- Pressures up to 1000 psi | 6900 kPa
- For coating options, download product submittal

### Approvals/Listings:



INSTALLATION-  
READY™



## Composite Flexible Coupling

STYLE 171

[Download submittal 06.22](#) for complete information

- For use where corrosive conditions exist
- Designed for use on reverse osmosis systems
- For use on roll/cut grooved PVC
- For stainless steel and FRP applications, contact Victaulic®
- Sizes from 1½–4" | 40–100 mm
- Pressures up to 150 psi | 1034 kPa



## Zero-Flex® Rigid Coupling

STYLE 07

[Download submittal 06.02](#) for complete information

- Angled bolt pad provides rigidity
- Sizes from 1–12" | 25–300 mm
- Pressures up to 750 psi | 5175 kPa
- For coating options, download product submittal
- For sizes 14–50" | 350–1250 mm, [download submittal 20.02](#) for information on AGS Style W07

### Approvals/Listings:



## Flexible Coupling

STYLE 77

[Download submittal 06.04](#) for complete information

- Cross-ribbed, two piece housing construction
- Sizes from ¾–24" | 20–600 mm
- Pressures up to 1000 psi | 6900 kPa
- For coating options, download product submittal
- For sizes 14–72" | 350–1825 mm, [download submittal 20.03](#) for information on AGS Style W77

### Approvals/Listings:



## Flexible Coupling

STYLE 75

[Download submittal 06.05](#) for complete information

- Lightweight coupling for moderate pressures
- Sizes from 1–8" | 25–200 mm
- Pressures up to 500 psi | 3450 kPa
- For coating options, download product submittal

### Approvals/Listings:



## Original Groove System (OGS)



## Reducing Coupling

STYLE 750

[Download submittal 06.08](#) for complete information

- Replaces two couplings and a reducing fitting
- Sizes from 2–10" | 50–275 mm
- Pressures up to 500 psi | 3450 kPa
- For coating options, download product submittal

## Approvals/Listings:



## Snap-Joint® Coupling

STYLE 78

[Download submittal 06.09](#) for complete information

- Designed for quick disconnect service
- Sizes from 1–8" | 25–200 mm
- Pressures up to 300 psi | 2065 kPa
- For coating options, download product submittal



## Outlet Coupling

STYLE 72

[Download submittal 06.10](#) for complete information

- Joining device to provide an integral reducing outlet
- Sizes from 1½–6" | 40–150 mm
- Pressures up to 500 psi | 3450 kPa
- For coating options, download product submittal

## Approvals/Listings:







Approvals/Listings:



## Vic-Boltless® Coupling and Tool

STYLES 791 AND 792

[Download submittal 06.11](#) for complete information

- Provides a secure, tamper resistant, low profile joint
- Installed only with Victaulic® Style 792 tool
- Sizes from 2–8" | 50–200 mm
- Pressures up to 700 psi | 4825 kPa
- For coating options, download product submittal



Approvals/Listings:



## High Pressure Rigid Coupling

STYLE HP-70

[Download submittal 06.12](#) for complete information

- Heavy housing for high pressure service
- Sizes from 2–16" | 50–400 mm
- Pressures up to 1000 psi | 6900 kPa
- For coating options, download product submittal



**Style XL77**  
Pipe-to-Fitting  
Connections

**Style XL79**  
Fitting-to-Fitting  
Connections



**XL Fittings for Rubber Lined Services**  
See pg. 22 for information.

## XL Couplings for use with XL Fittings

Style XL77 and XL79

[Download submittal 07.07](#) for complete information

- For use with XL (extended life) fittings
- Style XL77 for pipe-to-fitting connections
- Style XL79 for fitting-to-fitting connections
- Sizes from 3–12" | 80–300 mm
- For pressures up to 1000 psi | 6900 kPa

## Original Groove System (OGS)

**Vic-Ring® Coupling**

## STYLE 41

[Download submittal 16.04](#) for complete information

- Provided with a variety of ring options to maintain full pipe wall thickness for abrasive systems
- Sizes from 30–66" | 750–1675 mm
- Pressures up to 90 psi | 620 kPa
- For coating options, download product submittal
- For AGS Vic-Ring® products, see pg. 26

**Vic-Ring® Coupling**

## STYLE 44

[Download submittal 16.05](#) for complete information

- Provided with a variety of ring options to maintain full pipe wall thickness for abrasive systems
- Sizes from 4–60" | 100–1500 mm
- Pressures up to 175 psi | 1200 kPa
- For coating options, download product submittal
- For AGS Vic-Ring® products, see pg. 26



### Vic-Flange® Adapter

STYLE 741

[Download submittal 06.06](#) for complete information

- ANSI Class 125 and 150 flanges
- Also available for Australian Standard Table E and PN10
- Sizes from 2–24" | 50–600 mm
- Pressures up to 300 psi | 2065 kPa
- For coating options, download product submittal
- For AGS sizes 14–24" | 350–600 mm, [download submittal 20.04](#) for information on AGS Style W741

Approvals/Listings:



### Vic-Flange® Adapter

STYLE 743

[Download submittal 06.06](#) for complete information

- ANSI Class 300 flanges
- Also available for PN16 and JIS20K
- Sizes from 2–12" | 50–300 mm
- Pressures up to 720 psi | 4960 kPa
- For coating options, download product submittal

Approvals/Listings:





## Original Groove System (OGS)



## Approvals/Listings:





















## Fittings — Elbows

[Download submittal 07.01](#) for complete information on original grooved end fittings for carbon steel pipe

- Standard fitting pressure ratings conform to ratings of installed coupling
- All fittings supplied with grooves or shoulders for fast installation
- Fittings available from ¾–24" | 20–600 mm
- For coating options, download product submittal
- For AGS sizes 14–60" | 350–1500 mm, [download submittal 20.05](#) for complete information

## Elbows

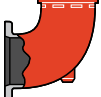
					
<b>No. 10</b> 90° Elbow	<b>No. 100</b> 90° Long Radius Elbow	<b>No. 100-1½D</b> 90° 1½ D Long Radius Elbow	<b>No. 100-3D</b> 90° 3 D Long Radius Elbow	<b>No. 100-5D</b> 90° 5 D Long Radius Elbow	<b>No. 100-6D</b> 90° 6 D Long Radius Elbow
					
<b>No. 11</b> 45° Elbow	<b>No. 110</b> 45° Long Radius Elbow	<b>No. 110-1½D</b> 45° 1½ D Long Radius Elbow	<b>No. 110-3D</b> 45° 3 D Long Radius Elbow	<b>No. 110-5D</b> 45° 5 D Long Radius Elbow	<b>No. 110-6D</b> 45° 6 D Long Radius Elbow
					
<b>No. 12</b> 22½° Elbow	<b>No. 13</b> 11¼° Elbow	<b>No. 18</b> 90° Adapter Elbows	<b>No. 19</b> 45° Adapter Elbows		
					
<b>No. 10-DR</b> Drain Elbow	<b>No. R-10G</b> Reducing Base Support Elbows (OGS Groove x OGS Groove)	<b>No. R-10F</b> Reducing Base Support Elbows (OGS Groove x Flange)			

All fittings are available with optional galvanized coating.



## Fittings — Tees, Crosses, Wyes and Laterals

[Download submittal 07.01](#) for complete information on original grooved end fittings for carbon steel pipe

- Standard fitting pressure ratings conform to ratings of installed coupling
- All fittings supplied with grooves or shoulders for fast installation
- Fittings available from ¾–24" | 20–600 mm
- For coating options, download product submittal
- For AGS sizes 14–60" | 350–1500 mm, [download submittal 20.05](#) for complete information

### Approvals/Listings:



### Tees, Crosses, Wyes, and Laterals



**No. 20**  
Tee

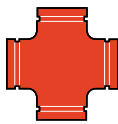

**No. 35**  
Cross



**No. 33**  
True Wye



**No. 29M**  
Tee with  
Threaded Branch



**No. 25**  
Grooved Branch  
Reducing Tee



**No. 29T**  
Threaded Branch  
Reducing Tee



**No. 21**  
Bullhead Tee



**No. 30**  
45° Lateral

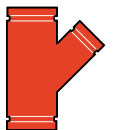

**No. 30-R**  
45° Reducing  
Lateral

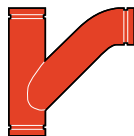

**No. 32**  
Tee Wye

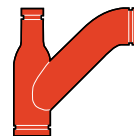

**No. 32-R**  
Reducing  
Tee Wye



## Original Groove System (OGS)



## Fittings — Adapters, Nipples, Caps and Plugs

[Download submittal 07.01](#) for complete information on original grooved end fittings for carbon steel pipe

- Standard fitting pressure ratings conform to ratings of installed coupling
- All fittings supplied with grooves or shoulders for fast installation
- Fittings available from  $\frac{3}{4}$ –24" | 20–600 mm
- For coating options, download product submittal
- For AGS sizes 14–60" | 350–1500 mm, [download submittal 20.05](#) for complete information

### Approvals/Listings:



### Adapters, Nipples, Caps and Plugs



**No. 40**  
Adapter Nipple  
(OGS Groove x  
Thread)



**No. 42**  
Adapter Nipple  
(OGS Groove x  
Bevel)



**No. 43**  
Adapter Nipple  
(OGS Groove x  
OGS Groove)



**No. 80**  
Female Threaded  
Adapter



**No. 53**  
Swaged Nipple  
(OGS Groove x  
OGS Groove)



**No. 54**  
Swaged Nipple  
(OGS Groove x  
Thread)



**No. 55**  
Swaged Nipple  
(Thread x  
OGS Groove)



**No. 60**  
Cap



**No. 61**  
Bull Plug



**No. 48**  
Hose Nipple



**No. 41**  
ANSI Class 125  
Flanged Adapter  
Nipple



**No. 45F**  
ANSI Class 150  
Flat Face Flanged  
Adapter Nipple



**No. 45R**  
ANSI Class 150  
Raised Face  
Flanged Adapter  
Nipple



**No. 46F**  
ANSI Class 300  
Flat Face Flanged  
Adapter Nipple



**No. 46R**  
ANSI Class 300  
Raised Face  
Flanged Adapter  
Nipple



## Fittings — Reducers

[Download submittal 07.01](#) for complete information on original grooved end fittings for carbon steel pipe

- Standard fitting pressure ratings conform to ratings of installed coupling
- All fittings supplied with grooves or shoulders for fast installation
- Fittings available from ¾–24" | 20–600 mm
- For coating options, download product submittal
- For AGS sizes 14–60" | 350–1500 mm, [download submittal 20.05](#) for complete information

### Approvals/Listings:



### Reducers



**No. 50**  
Concentric Reducer



**No. 51**  
Eccentric Reducer



**No. 52**  
Small Threaded Reducer



**No. 52F**  
BSPT Small Threaded Reducer



**No. XL100**  
1½D  
90° Elbow



**No. XL110**  
1½D  
45° Elbow



**XL Fittings for Rubber Lined Services**  
See pg. 22 for information.

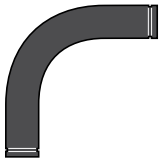

**No. XL100**  
3D  
90° Elbow



**No. XL110**  
3D  
45° Elbow

## Other Fitting Systems

[Download submittal 07.02](#) for long radius steel elbows (3D, 5D, and 6D)

[Download submittal 07.03](#) for EndSeal® Extra Heavy (ES) fittings

[Download submittal 07.04](#) for fabricated steel fittings (segmentally welded and full flow)

[Download submittal 07.07](#) for XL fittings

[Download submittal 14.04](#) for plain end fittings

[Download submittal 17.16](#) for stainless steel fittings

[Download submittal 18.11](#) for Type 316 Vic-Press® fittings

[Download submittal 18.12](#) for Type 304 Vic-Press® fittings

[Download submittal 20.05](#) for **AGS** fittings

[Download submittal 21.03](#) for aluminum fittings

[Download submittal 22.04](#) for copper fittings

[Download submittal 23.05](#) for AWWA fittings

[Download submittal 25.03](#) for alternate style fittings machined for rubber or urethane lining

[Download submittal 50.01](#) for Aquamine® fittings



## Original Groove System (OGS)

**Mover® Expansion Joint**

STYLE 150

[Download submittal 09.04](#) for complete information

- Slip-type expansion joint providing up to 3" | 80 mm axial end movement
- Sizes from 2–6" | 50–150 mm
- Pressures up to 350 psi | 2400 kPa
- For additional types of expansion joints, see pg. 35

**Expansion Joint**

STYLE 155

[Download submittal 09.05](#) for complete information

- Combination of couplings and short nipples, joined in tandem to provide increased expansion
- Sizes from ¾–24" | 20–600 mm
- For coating options, download product submittal
- For AGS sizes 14–24" | 350–600 mm, [download submittal 20.12](#) for information on Style W155
- For additional types of expansion joints, see pg. 35



## Vic-300® MasterSeal™ Butterfly Valve

SERIES 761

[Download submittal 08.20](#) for complete information

- Designed for bi-directional, dead end services to full working pressure
- Available bare, with gear operator, with lever lock handle and memory stop or with 10-position handle and memory stop
- Sizes from 2–12" | 50–300 mm
- Pressures up to 300 psi | 2065 kPa
- For AGS sizes 14–24" | 350–600 mm, [download submittal 20.06](#) for information on Series W761
- For AGS sizes 26–48" | 650–1200 mm, [download submittal 20.07](#) for information on Series W709



## Butterfly Valve

SERIES 700

[Download submittal 08.05](#) for complete information

- Two piece stem permits narrow disc design for low pressure drop performance
- Sizes from 1½–6" | 40–150 mm
- Pressures up to 200 psi | 1400 kPa

## Original Groove System (OGS)



## Vic-Check® Valve

SERIES 716H

[Download submittal 08.08](#) for complete information

- Features a stainless steel disc which seats against the o-ring seal, when mounted on the electroless nickel plated face
- Sizes from 2–3" | 50–80 mm
- Pressures up to 365 psi | 2500 kPa
- For AGS sizes 14–24" | 350–600 mm, [download submittal 20.08](#) for information on Series W715



## Vic-Check® Valve

SERIES 716

[Download submittal 08.08](#) for complete information

- Features an elastomer encapsulated disc and a welded in nickel seat
- Sizes from 4–12" | 100–300 mm
- Pressures up to 300 psi | 2065 kPa
- For AGS sizes 14–24" | 350–600 mm, [download submittal 20.08](#) for information on Series W715



## Venturi Check Valve

SERIES 779

[Download submittal 08.10](#) for complete information

- Provides a variety of functions unlike any other measuring device
- Sizes from 4–14" | 100–350 mm
- Pressures up to 300 psi | 2065 kPa



## Swinger® Swing Check Valve

SERIES 712

[Download submittal 08.11](#) for complete information

- Designed for use with Victaulic® grooved fittings and couplings for fast installation on inlet and outlet ports
- Sizes from 2–4" | 50–100 mm
- Pressures up to 300 psi | 2065 kPa



## Swinger® Swing Check Valve

SERIES 713

[Download submittal 08.11](#) for complete information

- Designed for use with Victaulic® grooved fittings and couplings for fast installation on inlet and outlet ports
- Available size is 2" | 50 mm
- Pressures up to 1000 psi | 6900 kPa



## Diverter Valve

SERIES 725

[Download submittal 08.40](#) for complete information

- Provides 180° service on backfill paste lines for increased efficiency and reduced downtime
- Available in 6" | 150 mm
- Pressures up to 1000 psi | 6900 kPa



## Original Groove System (OGS)



## Vic®-Ball Valve

SERIES 721

[Download submittal 08.14](#) for complete information

- Standard port, end-entry valve with a streamlined design for excellent flow characteristics
- Sizes from 4–6" | 100–150 mm
- Pressures up to 800 psi | 5515 kPa



## Vic®-Ball Valve

SERIES 726

[Download submittal 08.23](#) for complete information

- High pressure standard port ball valve with grooved ends
- Available with a lever operator or a gear operator
- Sizes from 1½–6" | 40–150 mm
- Pressures up to 1000 psi | 6900 kPa



## Ball Valve

SERIES 727

[Download submittal 08.42](#) for complete information

- High pressure enhanced port NACE-compliant ball valve
- Up to 1/3 better flow than competitive standard port ball valves
- Floating ball reduces torque requirements
- Sizes from 2–6" | 50–150 mm
- Pressure up to 1500 psi | 10350 kPa



## Brass Body Valve — Threaded

SERIES 722

[Download submittal 08.15](#) for complete information

- Standard port, female threaded end valve constructed from forged brass
- Sizes from ¼–2" | 8–50 mm
- Pressures up to 600 psi | 4135 kPa

### Approvals/Listings:



## Three Port Diverter

SERIES 723

[Download submittal 08.13](#) for complete information

- NACE MR-01-75 compliant, three-port ball valve with common bottom inlet for diverting flow 90° left or right
- Available in 2" | 50 mm size
- Pressures up to 600 psi | 4135 kPa



## Vic-Plug® Valve

SERIES 377

[Download submittal 08.12](#) for complete information

- Only eccentric grooved end plug valve made specifically for throttling services
- Sizes from 3–12" | 80–300 mm
- Pressures up to 175 psi | 1200 kPa

## Original Groove System (OGS)



## MTS Plug Valve

SERIES 465

[Download submittal 17.36](#) for complete information

- Typically used in reverse osmosis desalination plants for on/off and control services
- Sizes from 2–18" | 50–450 mm
- Pressures up to 1450 psi | 10000 kPa

## Triple Service (Duty) Assemblies

BUTTERFLY/CHECK VALVE

[Download submittal 08.09](#) for complete information

- Assembles with Style 107 rigid couplings or Style 177 flexible couplings
- Sizes from 2½–12" | 65–300 mm
- Pressures up to 300 psi | 2065 kPa
- For AGS sizes 14–24" | 350–600 mm, [download submittal 20.18](#) for more information



## Approvals/Listings:



## Triple Service (Duty) Assemblies

PLUG/CHECK VALVE

[Download submittal 08.09](#) for complete information

- Provides shut-off, throttling with positive mechanical memory and non-slam check service in one unit
- Sizes from 3–12" | 80–300 mm
- Pressures up to 175 psi | 1200 kPa



## Approvals/Listings:





## Suction Diffuser

### SERIES 731-D

[Download submittal 09.20](#) for complete information

- Provides optimum flow conditions at the inlet side of the pump
- ANSI Class 150 flange
- Also available with PN10/16, GB, JIS 10K or Australian Standard Table E flange
- Sizes from 3–12" | 80–300 mm
- Pressures up to 300 psi | 2065 kPa
- For AGS sizes 14–24" | 350–600 mm, [download submittal 20.20](#) for information on Series W731-D



## Vic-Strainer® Tee Type

### SERIES 730

[Download submittal 09.02](#) for complete information

- Lighter than flanged Y-type strainers and provides straight through flow for lower pressure drop
- Sizes from 1½–12" | 40–300 mm
- Pressures up to 750 psi | 5175 kPa
- For coating options, download product submittal
- For AGS sizes 14–24" | 350–600 mm, [download submittal 20.11](#) for information on Series W730



## Vic-Strainer® Wye Type

### SERIES 732

[Download submittal 09.03](#) for complete information

- Provides straight through flow for lower pressure drop
- Sizes from 2–12" | 50–300 mm
- Pressures up to 300 psi | 2065 kPa
- For coating options, download product submittal
- For AGS sizes 14–24" | 350–600 mm, [download submittal 20.19](#) for information on Series W732



## Original Groove System (OGS)



**No. 62ES**  
90° Elbow



**No. 63ES**  
45° Elbow



**No. 64ES**  
Header Tee

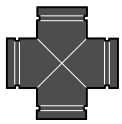

**No. 35ES**  
Cross

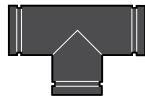

**No. 22ES**  
Tee

## EndSeal® System

**COUPLING: STYLE HP-70ES; FITTINGS: NO. 62ES, NO. 63ES, NO. 64ES, NO. 35ES, NO. 22ES**

[Download submittal 06.13](#) for the Style HP-70ES Coupling  
[Download submittal 07.03](#) for the ES Fittings

- For plastic coated pipe or high pressure rigid systems
- Schedule 80 wall thickness for use with HP-70ES couplings
- Coupling sizes from 2–12" | 50–300 mm and Fitting sizes from 2–6" | 50–150 mm
- Pressures up to 2500 psi | 17250 kPa
- For coating options, download product submittal



## High Pressure Coupling

**STYLE 808**

[Download submittal 15.01](#) for complete information

- Double-bolted coupling for use with Schedule 80 or heavier steel pipe
- Sizes from 6–12" | 150–300 mm
- Pressures up to 4000 psi | 27500 kPa
- For coating options, download product submittal





## XL (Extended Life) System for Rubber-lined Abrasive Services

[Download submittal 07.07](#) for complete information

- 1½D and 3D elbows designed for ¼" | 6 mm extra lining resulting in up to three times the service life when compared to standard rubber lined fittings
- Sizes from 3–12" | 80–300 mm
- Comes with Style XL77 flexible couplings for pipe-to-fitting and Style XL79 flexible couplings for fitting-to-fitting connections



**No. XL100**  
1½D  
90° Elbow



**No. XL110**  
1½D  
45° Elbow

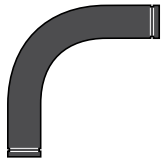

**No. XL100**  
3D  
90° Elbow



**No. XL110**  
3D  
45° Elbow



## Mechanical-T® Spigot Assembly

STYLE 926















[Download submittal 11.07](#) for complete information

- Mining tailings spigot assemblies for 22–26" | 550–650 mm tailings lines
- Features stainless steel strap and 7" | 178 mm outlet saddle
- Utilizes existing Victaulic® product to complete assembly
- Outlets compatible with steel or HDPE piping systems
- Pressure up to 170 psi | 1200 kPa

## Advanced Groove System **AGS**

Victaulic® offers a comprehensive portfolio of Advanced Groove System (AGS) couplings for systems 14–72" | 350–1825 mm and a full range of 14–48" | 350–1200 mm AGS fittings, valves and accessories. Our large diameter piping solutions provide strength and dependability in addition to speed, making them an excellent choice over welding. Other advantages AGS joints provide over welded joints include no flame installation, superior seismic-shock resistance and a union at every joint for easy adjustment, system maintenance or system expansion.



<b>Couplings</b>	<b>page</b>	<b>Fittings</b>	<b>page</b>
 AGS Flexible Coupling (Style W77)	25	 AGS Fittings	27
 AGS Rigid Coupling (Style W07)	25		
 AGS Stainless Steel Rigid Coupling (Style W89)	25		
		<b>Expansion Joints</b>	<b>page</b>
		 AGS Expansion Joint (Style W155)	28
<b>Vic-Ring® Couplings</b>	<b>page</b>		
 AGS Vic-Ring® Flexible Coupling (Style W77)	26	<b>Valves</b>	<b>page</b>
 AGS Vic-Ring® Rigid Coupling (Style W07)	26	 AGS Vic-300® Butterfly Valve (Series W761)	28
		 AGS Butterfly Valve (Series W709)	28
<b>Adapters</b>	<b>page</b>	 AGS Vic-Check® Dual Disc Valve (Style W715)	29
 AGS Vic-Flange® Adapter (Style W741)	26	 AGS Triple Service Valve Assembly	29
		<b>Strainers and Diffusers</b>	<b>page</b>
		 AGS Tee Type Vic-Strainer® (Series W730)	30
		 AGS Wye Type Vic-Strainer® (Series W732)	30
		 AGS Suction Diffuser (Series W731-D)	30



- Intro
- OGS
- AGS**
- VBSP
- Hole Cut
- Expansion Joints
- Plain End
- Stainless Steel
- Copper
- AWWA
- Hydraulic Balancing
- HDPE
- Aquamine® PVC
- Grooved PVC
- FRP
- Tools
- Gaskets/Seals/O-Rings
- Design Data
- Index

Advanced Groove System **AGS**

**2-piece design for faster installation**

First flat-pad rigid coupling design that installs metal-to-metal for visual inspection.

**HOUSING**

Wider housing profile for greater end load capability.



**GASKET**

The FlushSeal® gasket delivers more contact area for superior sealing.

**GROOVE**

Patented coupling locks into a deeper, wider, wedge-shaped groove for extremely strong, dependable joints.

**Original Groove System**

**HOUSING**

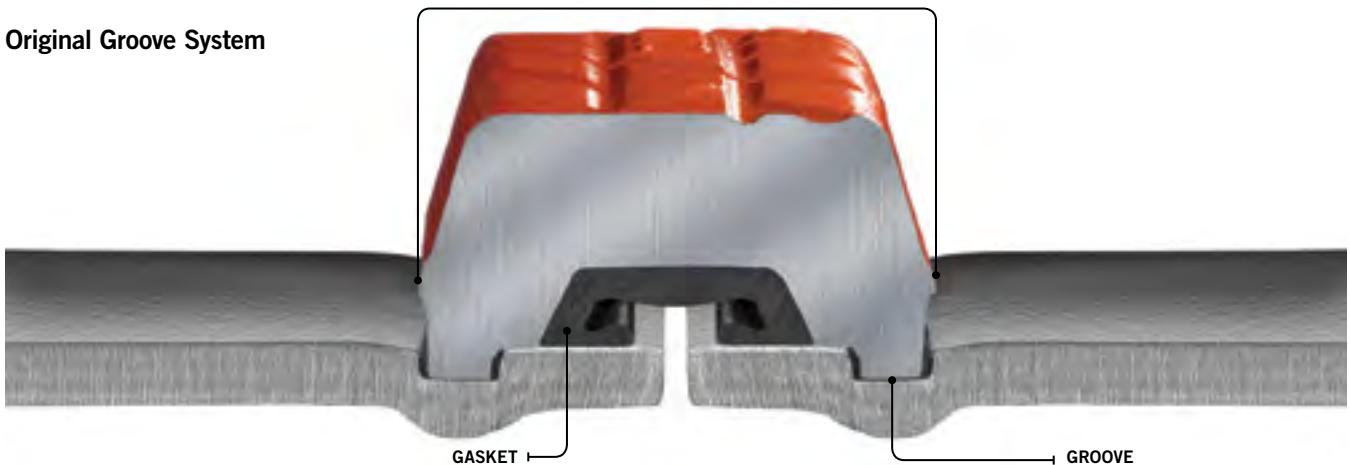

**GASKET**

**GROOVE**





## AGS Flexible Coupling

STYLE W77

[Download submittal 20.03](#) for complete information

- Unique wedge shaped key profile increases allowable pipe end separation
- Sizes from 14–72" | 350–1825 mm
- Pressures up to 350 psi | 2400 kPa
- For coating options, download product submittal
- For original groove sizes ¾–24" | 20–600 mm (Style 77), [download submittal 06.04](#);  
For original groove couplings featuring Installation-Ready™ technology sizes 2–8" | 50–400 mm (Style 177), [download submittal 06.20](#)



## AGS Rigid Coupling

STYLE W07

[Download submittal 20.02](#) for complete information

- First flat pad, metal-to-metal, rigid coupling to be offered in this size range
- Sizes from 14–50" | 350–1250 mm
- Pressures up to 350 psi | 2400 kPa
- For coating options, download product submittal
- For original groove sizes 1–12" | 25–300 mm (Style 07), [download submittal 06.02](#);  
For original groove featuring Installation-Ready™ technology sizes 2–12" | 50–300 mm (Style 107), [download submittal 06.21](#)



## AGS Stainless Steel Rigid Coupling

STYLE W89

[Download submittal 20.15](#) for complete information

- Wedge shaped coupling housing keys fully engage the patented AGS grooves to provide a rigid joint
- Sizes from 14–24" | 350–600 mm
- Pressures up to 300 psi | 2065 kPa
- For coating options, download product submittal
- For original groove sizes 2–12" | 50–300 mm, [download submittal 17.24](#) for information on Style 89



## AGS Vic-Ring® Flexible Coupling

STYLE W77

[Download submittal 16.12](#) for complete information

- Coupling installs on the supplied ring to maintain full pipe wall thickness on abrasive systems
- Sizes from 14–72" | 350–1825 mm
- Pressures up to 350 psi | 2400 kPa
- For coating options, download product submittal
- For OGS Vic-Ring® products, see pg. 7



## AGS Vic-Ring® Rigid Coupling

STYLE W07

[Download submittal 16.11](#) for complete information

- Coupling installs on the supplied ring to maintain full pipe wall thickness on abrasive systems
- Sizes from 14–48" | 350–1200 mm
- Pressures up to 350 psi | 2400 kPa
- For coating options, download product submittal
- For OGS Vic-Ring® products, see pg. 7



## AGS Vic-Flange® Adapter

STYLE W741

[Download submittal 20.04](#) for complete information

- Designed for directly incorporating flanged components with ANSI Class 125-150 bolt hole patterns
- Sizes from 14–24" | 350–600 mm
- Pressures up to 300 psi | 2065 kPa
- For coating options, download product submittal
- For original groove sizes 2–12" | 50–300 mm, [download submittal 06.06](#) for information on Style 741



## AGS Fittings

[Download submittal 20.05](#) for complete information

- Sizes from 14–60" | 350–1500 mm
- Pressures up to 350 psi | 2400 kPa
- For coating options, download product submittal
- For original groove fittings, [download submittal 07.01](#) for more information

### AGS Fittings



**No. W10**  
90° Elbow



**No. W11**  
45° Elbow



**No. W12**  
22½° Elbow



**No. W13**  
11¼° Elbow



**No. W100**  
90° 1½ D Long  
Radius Elbow



**No. W110**  
45° 1½ D Long  
Radius Elbow



**No. W20**  
Tee



**No. W35**  
Cross



**No. W33**  
True Wye



**No. W25**  
Reducing Tee



**No. W30**  
45° Lateral



**No. W30-R**  
45° Reducing  
Lateral



**No. W42**  
Adapter Nipple  
(AGS Groove x  
Bevel)



**No. W43**  
Adapter Nipple  
(AGS Groove x  
AGS Groove)



**No. W49**  
Adapter Nipple  
(AGS Groove x  
OGS Groove)



**No. W45R**  
Flanged  
Adapter Nipple



**No. W50**  
Concentric  
Reducer



**No. W51**  
Eccentric  
Reducer



**No. W60**  
Cap

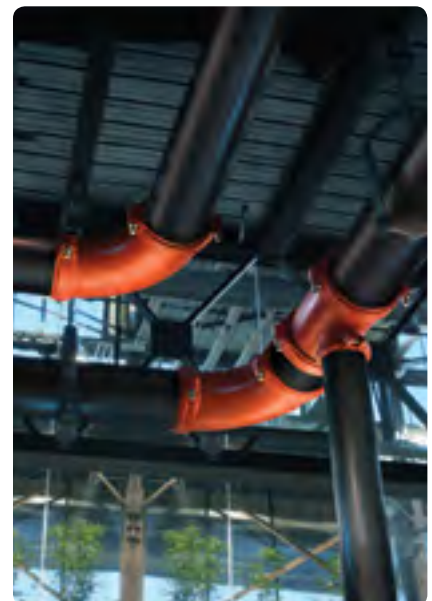



## AGS Expansion Joint

STYLE W155

[Download submittal 20.12](#) for complete information

- Combination of Style W77 couplings and short nipples, joined in tandem to provide increased expansion
- Sizes from 14–24" | 350–600 mm
- For coating options, download product submittal
- For original groove sizes 3–12" | 80–300 mm, [download submittal 09.05](#) for information on Style 155



## AGS Vic-300® Butterfly Valve

SERIES W761

[Download submittal 20.06](#) for complete information

- Offers an easily installed choice to cumbersome, multi-bolt wafer or lug-type flanged valves
- Sizes from 14–24" | 350–600 mm
- Pressures up to 300 psi | 2065 kPa
- For original groove sizes 2–12" | 50–300 mm, [download submittal 08.20](#) for information on Series 761



## AGS Butterfly Valve

SERIES W709

[Download submittal 20.07](#) for complete information

- Offers an easily installed choice to cumbersome, multi-bolt wafer or lug-type flanged valves
- Sizes from 26–48" | 650–1200 mm
- Pressures up to 150 psi | 1035 kPa



## AGS Vic-Check® Dual Disc Valve

### STYLE W715

[Download submittal 20.08](#) for complete information

- Utilizes a spring-assisted, dual disc design that achieves drop tight sealing
- Can be installed in both horizontal or vertical flow up positions
- Sizes from 14–24" | 350–600 mm
- Pressures up to 230 psi | 1575 kPa
- For original groove sizes 2–12" | 50–300 mm, [download submittal 08.08](#) for information on Series 716H/716 or [download submittal 08.10](#) for information on Series 779



## AGS Triple Service Valve Assembly

[Download submittal 20.18](#) for complete information

- Provides shut-off and throttling with positive mechanical memory
- Comprised of a Series W761 AGS butterfly valve and a Series W715 Vic-Check® valve
- Sizes from 14–24" | 350–600 mm
- Pressures up to 232 psi | 1600 kPa
- For original groove sizes 3–12" | 80–300 mm, [download submittal 08.09](#)





## AGS Tee Type Vic-Strainer®

SERIES W730

[Download submittal 20.11](#) for complete information

- Lighter than flanged Y-type strainers and provides straight through flow for lower pressure drop
- Sizes from 14–24" | 350–600 mm
- Pressures up to 300 psi | 2065 kPa
- For coating options, download product submittal
- For original groove sizes 1½–12" | 40–300 mm, [download submittal 09.02](#) for information on Series 730



## AGS Wye Type Vic-Strainer®

SERIES W732

[Download submittal 20.19](#) for complete information

- Provides straight through flow for lower pressure drop
- Sizes from 14–18" | 350–450 mm
- Pressures up to 300 psi | 2055 kPa
- For original groove sizes 2–12" | 50–300 mm, [download submittal 09.03](#) for information on Series 732



## AGS Suction Diffuser

SERIES W731-D

[Download submittal 20.20](#) for complete information

- Provides optimum flow conditions at the inlet side of the pump
- Sizes from 14–24" | 350–600 mm
- Pressures up to 300 psi | 2065 kPa
- For original groove sizes 3–12" | 80–300 mm, [download submittal 09.20](#) for information on Series 731-D

## Victaulic® Bolted Split-Sleeve Products (VBSP)

Victaulic® offers a variety of large diameter pipe joining solutions specifically designed to meet the needs of your system.

Conforming to AWWA C227, Victaulic® Bolted Split-Sleeve couplings are available in a range of unrestrained and restrained flexible designs for use on carbon steel, stainless steel, HDPE and other pipe materials.

Victaulic® Bolted Split-Sleeve couplings are designed for use on water and wastewater transmission lines as well as hydroelectric penstock lines. VBSP couplings can also provide expansion and contraction capabilities when needed.

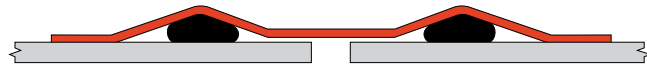



### Couplings

page

### Tools

page

 Non-Restrained Flexible Coupling for Carbon Steel Pipe (Style 230) 31

 Manual and Hydraulic Closure Tools 111

 Non-Restrained Flexible Coupling for Stainless Steel Pipe (Style 230S) 32

 Restrained Flexible Single-Gasket Coupling for Carbon Steel Pipe (Style 234) 32

 Restrained Flexible Single-Gasket Coupling for Stainless Steel Pipe (Style 234S) 32



## Non-Restrained Flexible Coupling for Carbon Steel Pipe

### STYLE 230

[Download submittal 60.01](#) for complete information

- Non-restrained flexible pipe joint for water and wastewater pipelines
- Sizes from 8–144" | 200–3600 mm
- Pressures up to 400 psi | 2750 kPa
- Up to ½" | 15 mm intermittent axial movement
- Satisfies the requirements of AWWA C227
- For coating options, download product submittal



## Non-Restrained Flexible Coupling for Stainless Steel Pipe

STYLE 230S

[Download submittal 60.02](#) for complete information

- Non-restrained flexible pipe joint used where corrosion resistance is required
- Sizes from 3–96" | 80–2400 mm
- Pressures up to 300 psi | 2065 kPa
- Up to ½" | 15 mm intermittent axial movement
- Satisfies the requirements of AWWA C227



## Restrained Flexible Single-Gasket Coupling for Carbon Steel Pipe

STYLE 234

[Download submittal 60.09](#) for complete information

- Sizes from 8–120" | 200–3000 mm
- Pressures up to 300 psi | 2065 kPa
- Designed for use on water transmission, force mains and penstock lines
- For coating options, download product submittal



## Restrained Flexible Single-Gasket Coupling for Stainless Steel Pipe

STYLE 234S

[Download submittal 60.10](#) for complete information

- Sizes from 8–60" | 200–1500 mm
- Pressures up to 200 psi | 1375 kPa
- Ideal for field joint connections requiring flexibility and thrust restraint

## Hole Cut Systems

Victaulic® developed the hole cut piping system concept to enable a fast and easy mid-pipe outlet solution that would not require welding. The system allows for a direct branch connection at any location where a hole can be cut in the pipe. Gaskets are molded to conform to the outer diameter of the pipe and are pressure responsive to provide a seal. Victaulic® hole cut products are mounted to the pipe using either a locating collar (Style 920 and 920N) or a toe and heel (Style 923 and 924), and provide a smooth flow area.

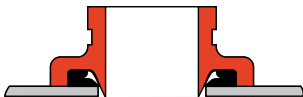
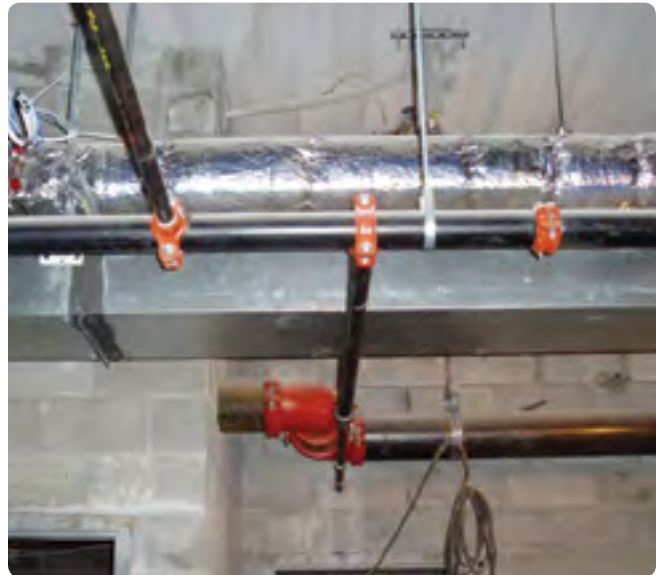

### Outlets and Couplings

page

### Tools

page



Mechanical-T® Outlet (Style 920/920N)

33



Vic-Tap® Hole Cutting Tools

105



Outlet Coupling (Style 72)

34



Vic-Let® Strapless Outlet (Style 923)

34



Vic-O-Well® Strapless Thermometer Outlet (Style 924)

34



## Mechanical-T® Outlet

STYLE 920/920N

[Download submittal 11.02](#) for complete information

- Provides a direct branch connection at any location where a hole can be cut in the pipe
- Available as a cross outlet, a female threaded outlet or a grooved outlet
- Sizes from 2–8" | 50–300 mm
- Pressures up to 500 psi | 3450 kPa
- For coating options, download product submittal

### Approvals/Listings:







## Outlet Coupling

STYLE 72

[Download submittal 06.10](#) for complete information

- Joining device to provide an integral reducing outlet
- Sizes from 1½–6" | 40–150 mm
- Pressures up to 500 psi | 3450 kPa
- For coating options, download product submittal

Approvals/Listings:



## Vic-Let® Strapless Outlet

STYLE 923

[Download submittal 11.05](#) for complete information

- Provides a fast, easy pipe outlet without the need for a strap or lower housing
- Sizes from 4–10" | 100–250 mm
- Pressures up to 300 psi | 2065 kPa

Approvals/Listings:



## Vic-O-Well® Strapless Thermometer Outlet

STYLE 924

[Download submittal 11.06](#) for complete information

- Provides a fast, easy connection, combining the features of a thermowell and strapless mechanical outlet
- Sizes from 4–10" | 100–250 mm
- Pressures up to 300 psi | 2065 kPa



## Expansion Joints







Victaulic® offers a wide variety of expansion solutions to accommodate pipe movement in your system.

Victaulic® expansion joints can provide from 4–42" | 100–1050mm of movement in a piping system. Select expansion joints allow for deflection as well as expansion and contraction capabilities. Stainless steel expansion joints are available for air systems requiring expansion compensators. Victaulic® expansion joints are available with Original Groove System (OGS), Advanced Groove System (AGS), bolted split-sleeve, and flanged ends.



### Expansion Joints

### page

	Mover® Expansion Joint (Style 150)	36
	Expansion Joint (Style 155)	36
	AGS Expansion Joint (Style W155)	36
	Non-Restrained Flexible Expansion Coupling for Carbon Steel Pipe (Style 231)	37
	Non-Restrained Flexible Expansion Coupling for Stainless Steel Pipe (Style 231S)	37
	Expansion Joint Coupling (Style 152A)	38
	Stainless Steel Bellow Expansion Joint (Style 240S)	39



## Mover® Expansion Joint

STYLE 150

[Download submittal 09.04](#) for complete information

- Slip-type expansion joint providing up to 3" | 80 mm axial end movement
- Sizes from 2–6" | 50–150 mm
- Pressures up to 350 psi | 2400 kPa
- For coating options, download product submittal



## Expansion Joint

STYLE 155

[Download submittal 09.05](#) for complete information

- Combination of couplings and short nipples, joined in tandem to provide increased expansion
- Sizes from ¾–24" | 20–600 mm
- For coating options, download product submittal
- For AGS sizes 14–24" | 350–600 mm, [download submittal 20.12](#) for information on Style W155



## AGS Expansion Joint

STYLE W155

[Download submittal 20.12](#) for complete information

- Combination of Style W77 couplings and short nipples, joined in tandem to provide increased expansion
- Sizes from 14–24" | 350–600 mm
- For coating options, download product submittal
- For original groove sizes 3–12" | 80–300 mm, [download submittal 09.05](#) for information on Style 155

## Expansion Joints



### Non-Restrained Flexible Expansion Coupling for Carbon Steel Pipe

STYLE 231

[Download submittal 60.03](#) for complete information

- Non-restrained flexible expansion joint provides up to 4" | 100 mm of axial movement
- Sizes from 16–144" | 400–3600 mm
- Pressures up to 300 psi | 2065 kPa
- Satisfies the requirements of AWWA C227
- For coating options, download product submittal



### Non-Restrained Flexible Expansion Coupling for Stainless Steel Pipe

STYLE 231S

[Download submittal 60.04](#) for complete information

- Flexible non-restrained expansion joint for aeration systems
- Sizes from 3–96" | 80–2400 mm
- Pressures up to 300 psi | 2065 kPa
- Up to 4" | 100 mm axial movement
- Satisfies the requirements of AWWA C227

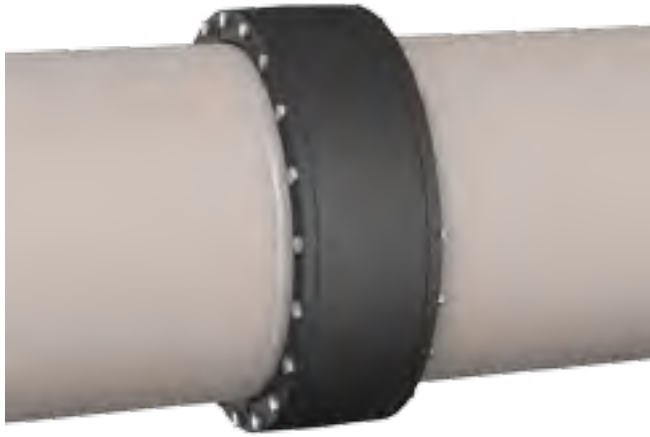

## Expansion Joint Coupling

STYLE 152A

[Download submittal 09.15](#) for complete information

- Large diameter pulverized coal/limestone coupling with 4° of deflection capability
- Sizes from 10–30" | 250–750 mm
- Pressures up to 50 psi | 345 kPa

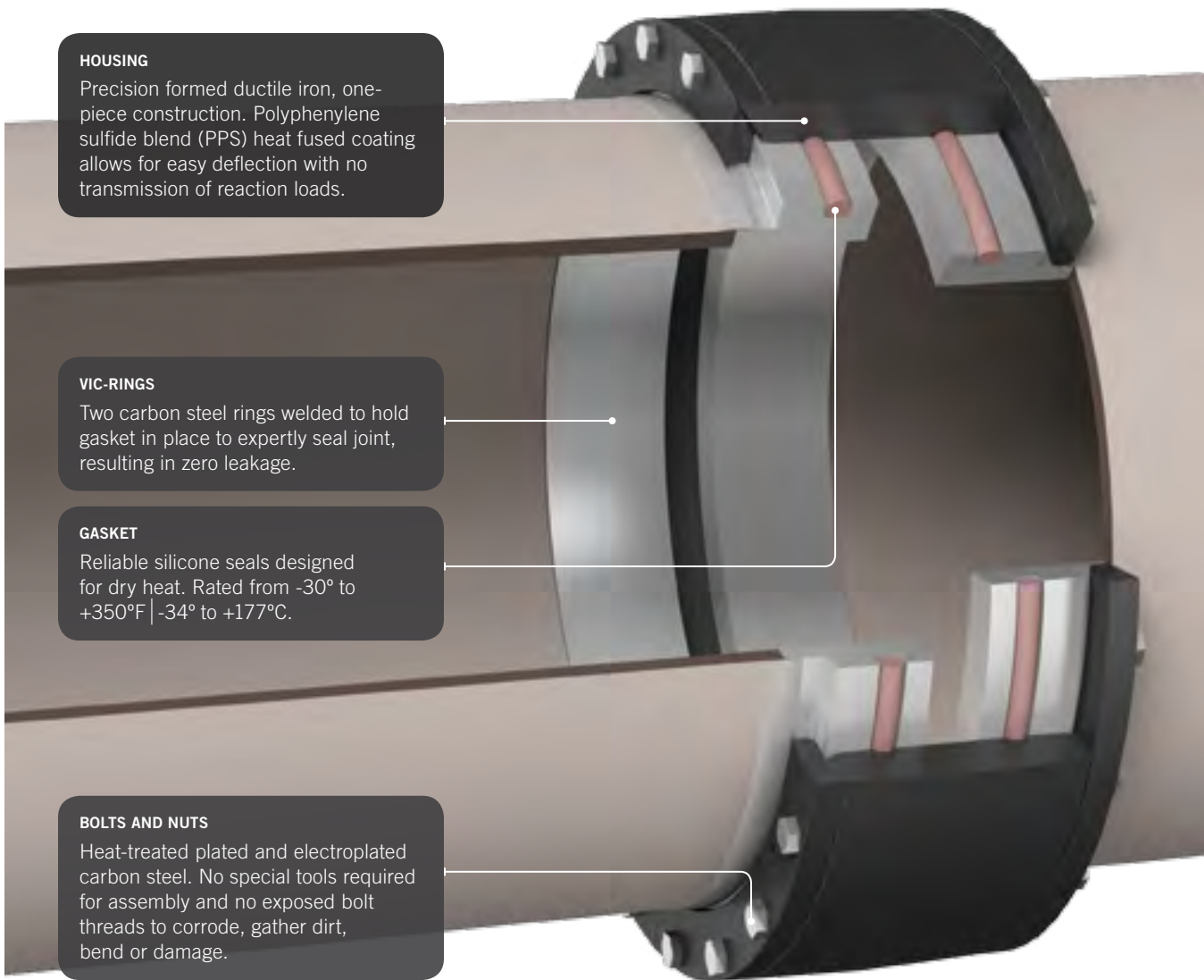

**HOUSING**

Precision formed ductile iron, one-piece construction. Polyphenylene sulfide blend (PPS) heat fused coating allows for easy deflection with no transmission of reaction loads.

**VIC-RINGS**

Two carbon steel rings welded to hold gasket in place to expertly seal joint, resulting in zero leakage.

**GASKET**

Reliable silicone seals designed for dry heat. Rated from -30° to +350°F | -34° to +177°C.

**BOLTS AND NUTS**

Heat-treated plated and electroplated carbon steel. No special tools required for assembly and no exposed bolt threads to corrode, gather dirt, bend or damage.

## Expansion Joints



## Stainless Steel Bellow Expansion Joint

STYLE 240S

[Download submittal 60.13](#) for complete information

- Concurrent axial, angular and/or lateral pipe movement possible
- Lateral offset at pipeline joints
- Designed to job-specific parameters
- Sizes from 3–96" | 80–2400 mm

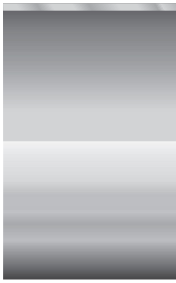

Plain End

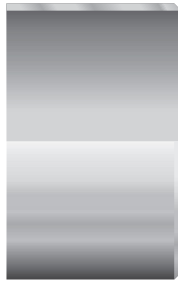

Beveled End



Restraint Ring



Roll Groove

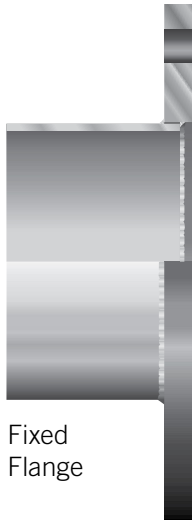

Fixed Flange



Floating Flange







## Plain End Systems for Carbon Steel

The Victaulic® plain end piping method is ideal for maintenance and repairs as well as new systems such as roof drains, slurries, tailings and oil field services. Roust-A-Bout® couplings and plain end fittings are UL and ULC Listed for fire protection services.

Victaulic® plain end couplings are primarily designed for use on standard weight steel pipe (Schedule 40), but may be used on light wall steel or other metallic pipe, such as aluminum or stainless steel. They are not intended for use on plastic pipe, plastic-coated pipe or brittle pipe, such as asbestos cement or cast iron. Nor are they intended for use on pipe with a surface hardness greater than 150 Brinell.

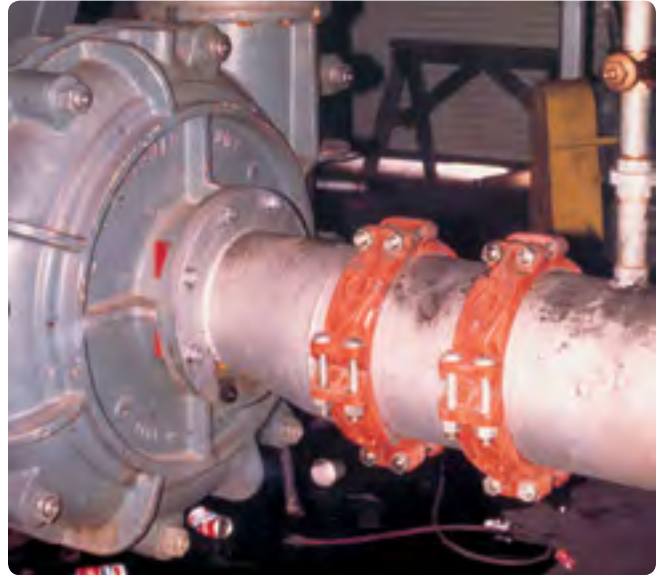

### Couplings

page

### Fittings

page

 Roust-A-Bout® Plain End Coupling (Style 99) 41

 Fittings 42



## Roust-A-Bout® Plain End Coupling STYLE 99

[Download submittal 14.02](#) for complete information

- Grips to provide a strong component for joining plain and beveled end pipe and fittings
- Not designed for use with plastic pipe
- Sizes from 1–18" | 25–450 mm
- Pressures up to 750 psi | 5175 kPa
- For coating options, download product submittal



## Fittings

[Download submittal 14.04](#) for complete information

- Provides change of direction to plain end piping systems
- Ready to install fitting
- Compatible with Style 99 Roust-A-Bout® coupling
- For coating options, download product submittal



**No. 10P**  
90° Elbow



**No. 11P**  
45° Elbow

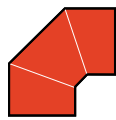

**No. 100P**  
90° Long  
Radius Elbow



**No. 110P**  
45° Long  
Radius Elbow

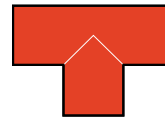

**No. 20P**  
Tee

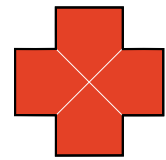

**No. 35P**  
Cross



**No. 33P**  
True Wye



**No. 61P**  
Steel Bull Plug

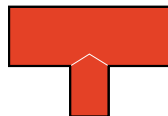

**No. 25P**  
Reducing Tee

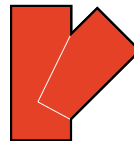

**No. 30P**  
45° Lateral



**No. 53P**  
Swaged Nipple



**No. 40P**  
Adapter Nipple  
(Plain End x  
Thread)



**No. 42P**  
Adapter Nipple  
(Plain End x  
Bevel)



**No. 43P**  
Adapter Nipple  
(Plain End x  
Groove)

## Stainless Steel Systems

The Victaulic® grooved system for stainless steel pipe offers a fast, easy and reliable method for joining ANSI and ISO wall thickness stainless steel pipe. For light wall and thin wall stainless steel pipe, specially designed RX rolls are used to create the proper groove profile required for installing Victaulic® products ([download submittal 17.01](#) for more detail.)

The revolutionary Vic-Press® for schedule 10S system provides quick, easy and safe installation and maintenance. It has the integrity to stand up to the demands of industrial applications by providing a positive mechanical interlock between the pipe and the fitting. The Vic-Press® for Schedule 10S press-to-connect system joins off-the-shelf ASTM A-312 stainless steel pipe.

In addition to the products listed below, the following Victaulic products may also be used on Stainless Steel pipe. Refer to the individual product submittals for additional information.

- [Style 07 Rigid Coupling](#)
- [Style HP-70 Rigid Coupling](#)
- [Style 75 Flexible Coupling](#)
- [Style 77 Flexible Coupling](#)
- [Style 171 Flexible Coupling](#)
- [Style 78 Snap Joint Coupling](#)
- [Style 791 Boltless Coupling](#)
- [Style 741 Flange Adapter](#)
- [Style 743 Flange Adapter](#)

Couplings		page	Fittings		page
	Type 316 Rigid Coupling (Style 489)	44		ANSI Schedule 10S Fittings	47
	Rigid Coupling (Style 89)	44		ANSI Schedule 40S Fittings	48
	Duplex Rigid Coupling (Style 489DX)	45	<b>Valves</b>		
	Type 316 Flexible Coupling (Style 77S)	45		Butterfly Valve (Series 763)	49
	Type 316 Lightweight Flexible Coupling (Style 475)	45		Swinger® Check Valve (Series 712S)	49
	Duplex Flexible Coupling (Style 77DX)	46		Vic-Ball® Valve (Series 726S)	49
	Duplex Flexible Coupling (Style 475DX)	46		Vic-Ball® Valve (Series 726D)	50
<b>Adapters</b>		<b>page</b>		Three-Piece Vic-Press® Ball Valve (Series P569 Groove x Groove)	50
	Type 316 Vic-Flange® Adapter (Style 441)	46		MTS Plug Valve (Series 465)	50
			<b>Vic-Press®</b>		
				For Schedule 10 Stainless Steel 304	51
				For Schedule 10 Stainless Steel 316	52

Regardless of the coupling selected to join stainless steel pipe, the Victaulic® pressure responsive elastomeric gasket seals the joint. Stainless steel housings provide the highest level of protection against external corrosion, while ductile iron couplings can be used to join stainless steel pipe in non-corrosive environments. For pressure ratings and end loads for ductile iron couplings on stainless steel pipe, [download submittal 17.09](#).



## Type 316 Rigid Coupling

STYLE 489

[Download submittal 17.25](#) for complete information

- Greatly reduces linear or angular movement and is useful for valve connections where rigidity is required
- Sizes from 1½–12" | 40–300 mm
- Pressures up to 600 psi | 4135 kPa
- For the duplex stainless steel coupling, [download submittal 17.33](#) for Style 489DX



## Rigid Coupling

STYLE 89

[Download submittal 17.24](#) for complete information

- Greatly reduces linear or angular movement and is useful for valve connections where rigidity is required
- Galvanized coated ductile iron coupling
- Sizes from 2–12" | 50–300 mm
- Pressures up to 1200 psi | 8275 kPa
- For the duplex stainless steel coupling, [download submittal 17.33](#) for Style 489DX



## Stainless Steel Systems



## Duplex Rigid Coupling

STYLE 489DX

[Download submittal 17.33](#) for complete information

- Greatly reduces linear or angular movement and is useful for valve connections where rigidity is required
- Sizes from 2–12" | 50–300 mm
- Pressures up to 1200 psi | 8275 kPa
- Optional super duplex stainless steel housing
- For the Type 316 stainless steel coupling, [download submittal 17.25](#) for Style 489



## Type 316 Flexible Coupling

STYLE 77S

[Download submittal 17.03](#) for complete information

- Provides a rugged mechanical joint for grooved end stainless steel piping systems
- Sizes from 8–18" | 200–450 mm
- Pressures up to 300 psi | 2065 kPa
- For sizes ¾–6" | 20–150 mm, [download submittal 17.20](#) for information on Style 77DX



## Type 316 Lightweight Flexible Coupling

STYLE 475

[Download submittal 17.14](#) for complete information

- Designed to provide a durable mechanical joint for grooved end stainless steel piping systems
- Sizes from 1–4" | 25–100 mm
- Pressures up to 500 psi | 3450 kPa



## Duplex Flexible Coupling

STYLE 77DX

[Download submittal 17.20](#) for complete information

- Designed to provide a rugged mechanical joint for roll grooved stainless steel systems
- Sizes from ¾–6" | 20–150 mm
- Pressures up to 1200 psi | 8275 kPa
- Optional super duplex stainless steel housing
- For sizes 8–18" | 200–450 mm, [download submittal 17.03](#) for information on Style 77S



## Duplex Lightweight Flexible Coupling

STYLE 475DX

[Download submittal 17.34](#) for complete information

- Unique coupling design permits assembly by removing one nut/bolt and scissoring housing over gasket
- Sizes from 1–4" | 25–100 mm
- Pressures up to 500 psi | 3450 kPa
- Optional super duplex stainless steel housing
- For the Type 316 stainless steel coupling, [download submittal 17.14](#) for Style 475



## Vic-Flange® Adapter

STYLE 441

[Download submittal 17.27](#) for complete information

- ANSI Class 150 flanges
- Also available for ISO PN10/16
- Constructed from Grade CF8M stainless steel, making it ideal for externally corrosive environments
- Sizes from 2–6" | 50–150 mm
- Pressures up to 275 psi | 1900 kPa

## Stainless Steel Systems



## ANSI Schedule 10S Fittings

[Download submittal 17.16](#) for complete information

- Grooved ends eliminate pipe end preparation for the fittings
- Sizes from ¾ – 12" | 20–300 mm
- Available in Type 304L or 316L



**No. 410 SS**  
90° Elbow



**No. 411 SS**  
45° Elbow



**No. 412 SS**  
22½° Elbow



**No. 413 SS**  
11¼° Elbow

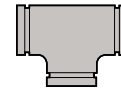

**No. 420 SS**  
Tee

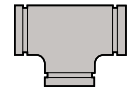

**No. 20 SS**  
Tee

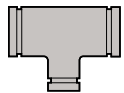

**No. 425 SS**  
Grooved Branch  
Reducing Tee

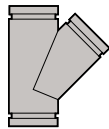

**No. 430 SS**  
45° Lateral

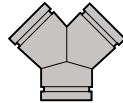

**No. 433 SS**  
True Wye

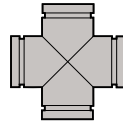

**No. 435 SS**  
Cross



**No. 442 SS**  
Adapter Nipple  
(Groove x  
Bevel)



**No. 443 SS**  
Adapter Nipple  
(Groove x  
Groove)



**No. 450 SS**  
Concentric  
Reducer



**No. 451 SS**  
Eccentric  
Reducer



**No. 460 SS**  
Cap



**No. 445F**  
Flat Face Flanged  
Adapter Nipple



**No. 445R**  
Raised Face Flanged  
Adapter Nipple



## ANSI Schedule 40S Fittings

[Download submittal 17.16](#) for complete information

- Grooved ends eliminate pipe end preparation for the fittings
- Sizes from  $\frac{3}{4}$  – 12" | 20–300 mm
- Available in Type 304L or 316L
- Designed for higher pressure systems



**No. 410HSS**  
90° Elbow



**No. 411HSS**  
45° Elbow



**No. 412HSS**  
22½° Elbow



**No. 413HSS**  
11¼° Elbow

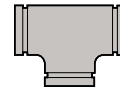

**No. 420HSS**  
Tee

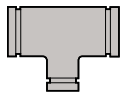

**No. 425HSS**  
Grooved Branch  
Reducing Tee

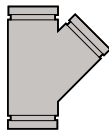

**No. 430HSS**  
45° Lateral

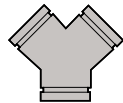

**No. 433HSS**  
True Wye

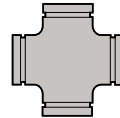

**No. 435HSS**  
Cross



**No. 440HSS**  
Adapter Nipple  
(Groove x  
Thread)



**No. 442HSS**  
Adapter Nipple  
(Groove x  
Bevel)



**No. 443HSS**  
Adapter Nipple  
(Groove x  
Groove)



**No. 450HSS**  
Concentric  
Reducer



**No. 451HSS**  
Eccentric  
Reducer



**No. 60SS**  
Cap

## Stainless Steel Systems



### Butterfly Valve

SERIES 763

[Download submittal 17.23](#) for complete information

- The disc is constructed of stainless steel and provides a bubble-tight shut-off at full rated pressure
- Available with a tamper resistant lever handle or a gear operator
- Sizes from 2–10" | 50–250 mm
- Pressures up to 300 psi | 2065 kPa



### Swinger® Check Valve

SERIES 712S

[Download submittal 17.08](#) for complete information

- The large closure access bonnet permits easy access for in-line service
- Designed for use with standard Victaulic® grooved fittings and couplings for fast installation on inlet and outlet ports
- Available in size 2" | 50 mm



### Vic-Ball® Valve

SERIES 726S

[Download submittal 17.22](#) for complete information

- High pressure Type 316 stainless steel standard port ball valve with grooved ends
- Sizes from 1½–6" | 40–150 mm
- Pressures up to 1000 psi | 6900 kPa





## Vic-Ball® Valve

SERIES 726D

[Download submittal 17.28](#) for complete information

- High pressure super duplex stainless steel standard port ball valve with grooved ends
- Sizes from 2–6" | 50–150 mm
- Pressures up to 1200 psi | 8275 kPa



## Three-Piece Vic-Press® Ball Valve

SERIES P569 (Grv. x Grv.)

[Download submittal 18.14](#) for complete information

- The three-piece swing-out design permits easy in-line maintenance.
- Sizes from ½–2" | 15–50 mm
- Pressures up to 400 psi | 2750 kPa
- For the entire Vic-Press® line of products, see pgs. 51 and 52



## MTS Plug Valve

SERIES 465

[Download submittal 17.36](#) for complete information

- Typically used in reverse osmosis desalination plants for on/off and control services
- Sizes from 2–18" | 50–450 mm
- Pressures up to 1450 psi | 10000 kPa

## Stainless Steel Systems



## Vic-Press® For Schedule 10S Stainless Steel Type 304

[Download submittal 18.12](#) for complete information

- Fast, easy, reliable way to join small diameter Type 304/304L stainless steel
- Meet ASME requirements for ANSI Class 150 systems
- Designed for systems from ½–2" | 15–50 mm for working pressures up to 500 psi | 3450 kPa

	Connection Key					
	<b>P</b> Press <b>F</b> Female Thread <b>M</b> Male Thread <b>T</b> Plain End <b>L</b> Flanged <b>G</b> Grooved					
<b>Style P597</b> Standard Coupling (P × P)	<b>Style P586</b> Short Tangent 90° Elbow (P × P)	<b>Style P542</b> 90° Street Elbow (P × T)	<b>Style P591</b> 45° Elbow (P × P)	<b>Style P543</b> 45° Street Elbow (P × T)		
<b>Style P592</b> Tee (P × P × P)	<b>Style P588</b> Tee with Threaded Branch (P × P × F)	<b>Style P593</b> Tee with Reducing Branch (P × P × P)	<b>Style P596</b> Male Threaded Adapter (P × M)	<b>Style P599</b> Female Threaded Adapter (P × F)	<b>Style P561</b> Weld Adapter (P × T)	
<b>Style P584</b> Threaded Union (P × P)	<b>Style P595</b> Flange Adapter (P × L)	<b>Style P565</b> Van Stone Flange Adapter (P × L)	<b>Style P587</b> Transition Nipple (G × T)	<b>Style P594</b> Concentric Reducer (P × P)	<b>Style P540</b> End Cap	
<b>Style P569</b> Stainless Steel Ball Valve (P × P shown) (G × G and P × G also available)	<b>Style P589</b> Brass Body Ball Valve (P × P)		<b>PFT510</b> Vic-Press® Tool, pg. 107			



## Vic-Press® For Schedule 10S Stainless Steel Type 316

[Download submittal 18.11](#) for complete information

- Fast, easy, reliable way to join small diameter Type 316/316L stainless steel
- Meet ASME requirements for ANSI Class 150 systems
- Designed for systems from ½–2" | 15–50 mm for working pressures up to 500 psi | 3450 kPa



**Style P507**  
Standard Coupling  
(P × P)

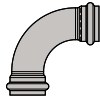

**Style P568**  
Short Tangent 90° Elbow  
(P × P)

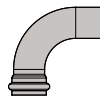

**Style P562**  
90° Street Elbow  
(P × T)

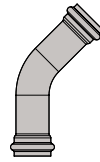

**Style P571**  
45° Elbow  
(P × P)

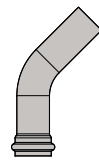

**Style P563**  
45° Street Elbow  
(P × T)

### Connection Key

- P** Press
- F** Female Thread
- M** Male Thread
- T** Plain End
- L** Flanged
- G** Grooved



**Style P508**  
Slip Coupling  
(P × P)



**Style P572**  
Tee  
(P × P × P)

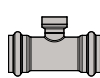

**Style P578**  
Tee with Threaded Branch  
(P × P × F)

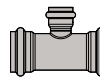

**Style P573**  
Tee with Reducing Branch  
(P × P × P)



**Style P576**  
Male Threaded Adapter  
(P × M)



**Style P579**  
Female Threaded Adapter  
(P × F)

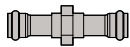

**Style P585**  
Threaded Union  
(P × P)



**Style P575**  
Flange Adapter  
(P × L)



**Style P566**  
Van Stone Flange Adapter  
(P × L)



**Style P577**  
Transition Nipple  
(G × T)



**Style P574**  
Concentric Reducer  
(P × P)



**Style P560**  
End Cap

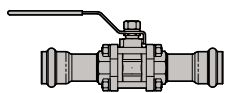

**Style P569**  
Stainless Steel Ball Valve  
(P × P shown)  
(G × G and P × G also available)

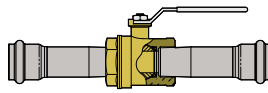

**Style P589**  
Brass Body Ball Valve  
(P × P)



**PFT510**  
Vic-Press® Tool,  
pg. 107

## Copper Systems

The Victaulic® original grooved copper system offers a full line of couplings, fittings and valves for systems rated up to 300 psi | 2065 kPa, as well as a line of roll grooving tools for on-site grooving. The Victaulic® grooved copper system is cold-formed, eliminating the need for soldering or brazing. The copper connection system joins 2–8" | 50–200 mm type K, L, M or DWV copper.



### Couplings

 QuickVic® Rigid Coupling (Style 607)

page

53

### Dielectric Waterway Fitting

page

 Dielectric Waterway Fitting

55

### Adapters

page

 Vic-Flange® Adapter for Copper (Style 641)

54

### Valves

page

 Butterfly Valve for Copper (Series 608N)

56

### Fittings

page

 Fittings for Copper

54

### Outlets

page

 Mechanical-T® Bolted Branch Outlet and Cross Assemblies for Copper (Style 622)

56

INSTALLATION-READY™



## QuickVic® Rigid Coupling

STYLE 607

[Download submittal 22.13](#) for complete information

- Installation-Ready™ design
- Designed for use on K, L, M or DWV copper tubing
- Sizes from 2–8" | 50–200 mm
- Pressures up to 300 psi | 2065 kPa
- Optional galvanized housing coating

### Approvals/Listings:





## Vic-Flange® Adapter for Copper

STYLE 641

[Download submittal 22.03](#) for complete information

- Available for CTS, DIN, BS and AS copper systems
- Sizes from 2–6" | 50–150 mm
- Pressures up to 300 psi | 2065 kPa

### Approvals/Listings:



## Fittings for Copper

[Download submittal 22.04](#) for complete information

- Full-flow, standard radius copper fittings are supplied as either roll grooved copper or bronze fittings
- Designed for installation in copper systems using either a Style 607 rigid coupling or a Style 641 Vic-Flange® adapter
- Sizes from 2–8" | 50–200 mm
- Pressures up to 300 psi | 2065 kPa

### Approvals/Listings:



**No. 610**  
90° Elbow



**No. 611**  
45° Elbow

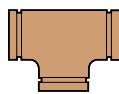

**No. 620**  
Tee

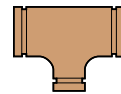

**No. 625**  
Reducing Tee  
(Groove x Groove  
x Groove)

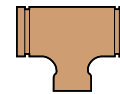

**No. 626**  
Reducing Tee  
(Groove x Groove  
x Cup)



**No. 650**  
Concentric  
Reducer  
(Groove x  
Groove)



**No. 652**  
Concentric  
Reducer  
(Groove x  
Cup)



**No. 660**  
Cap



## Copper Systems



## Dielectric Waterway Fitting

### STYLE 647

[Download submittal 22.21](#) for complete information

- Used to join carbon steel or stainless steel pipe to copper tubing with one fitting
- Available in groove x groove, groove x thread or thread x thread
- Sizes from ½–4" | 15–100 mm
- Pressures up to 300 psi | 2065 kPa



## Butterfly Valve for Copper

SERIES 608N

[Download submittal 22.14](#) for complete information

- Joins quickly to copper tube by utilizing Style 607 Installation-Ready™ couplings
- Sizes from 2½–6" | 65–150 mm
- Pressures up to 300 psi | 2065 kPa



## Mechanical-T® Bolted Branch Outlet and Cross Assemblies for Copper

STYLE 622

[Download submittal 22.12](#) for complete information

- Provides a direct branch connection at any location on K, L and M copper tubing
- Sizes from 2½–4" | 65–100 mm
- Pressures up to 300 psi | 2065 kPa

### Approvals/Listings:



## AWWA Systems

The Victaulic® grooved AWWA piping system is the fastest and easiest method for joining AWWA size pipe with 75% fewer bolts than flanging. Victaulic® grooved piping components are available for use on AWWA C-606 class 53 pipe or heavier and have a pressure rating of up to 500 psi | 3450 kPa and a size range from 3–36" | 80–900 mm. FlushSeal® gaskets are specifically designed to seal on ductile iron pipe surfaces providing a triple seal to promote leak-free service for the life of the system.

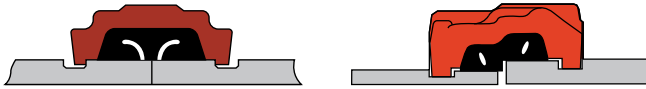

### Couplings

- |   | <b>page</b> |
|---|-------------|
| Coupling for AWWA Ductile Iron Pipe (Style 31)  | 58          |
| Transition Coupling for IPS to AWWA (Style 307) | 58          |

### Adapters

- |  | <b>page</b> |
|--|-------------|
| Vic-Flange® Adapter for AWWA (Style 341) | 58          |

### Fittings

- |                                  | <b>page</b> |
|----------------------------------|-------------|
| Elbows                           | 59          |
| Tees, Crosses, Wyes and Laterals | 60          |
| Reducers, Flares, and Outlets    | 61          |

### Valves

- |                                       | <b>page</b> |
|---------------------------------------|-------------|
| Check Valve for AWWA (Series 317)     | 62          |
| Vic-Plug® Valve for AWWA (Series 365) | 63          |



## Coupling for AWWA Ductile Iron Pipe

STYLE 31

[Download submittal 23.02](#) for complete information

- Provides a rigid or flexible joint on Class 53 or higher pipe
- Sizes from 3–36" | 80–900 mm
- Pressures up to 500 psi | 3450 kPa
- Optional coatings include orange enamel, coal tar epoxy, organic zinc primer and bituminous

Approvals/Listings:



## Transition Coupling for IPS to AWWA

STYLE 307

[Download submittal 23.03](#) for complete information

- Single transition for connecting grooved end IPS steel to grooved end AWWA ductile iron
- Designed for Class 53 or higher pipe
- Sizes from 3–12" | 80–300 mm
- Pressures up to 500 psi | 3450 kPa
- Optional coatings include galvanized, organic zinc primer and bituminous

Approvals/Listings:



## Vic-Flange® Adapter for AWWA

STYLE 341

[Download submittal 23.04](#) for complete information

- Designed for direct connection of flanged components into a grooved cast or ductile system
- Designed for Class 53 or higher pipe
- Sizes from 3–24" | 80–600 mm
- Pressures up to 250 psi | 1725 kPa
- Optional coatings include coal tar epoxy, organic zinc primer and bituminous

Approvals/Listings:





## AWWA — Elbows

[Download submittal 23.05](#) for complete information

- AWWA size fittings are supplied with rigid radius grooves in accordance with ANSI/AWWA C-606
- Fittings conform to ANSI 21.10/AWWA C-110 for center-to-end dimensions and AWWA C-153 or ANSI 21.10/AWWA C-110 for wall thicknesses
- Available with a wide variety of coatings and linings
- Victaulic® can supply tapped fittings that meet ANSI B16.1 dimension locations; specify fitting size, tap location by letter on order
- Sizes from 3–36" | 80–900 mm
- Pressure rated up to 350 psi | 2400 kPa

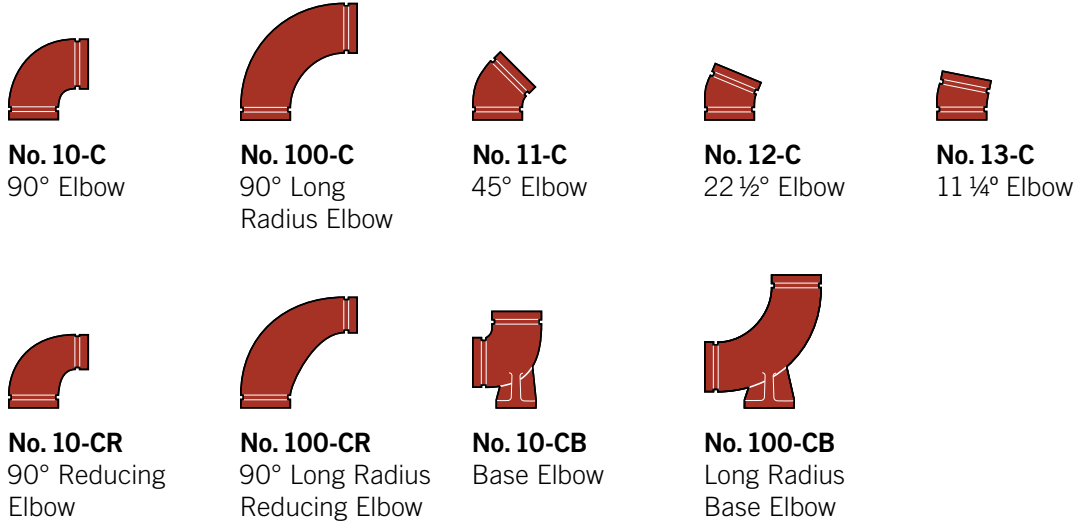





## AWWA—Tees, Crosses, Wyes, Laterals

[Download submittal 23.05](#) for complete information

- AWWA size fittings are supplied with rigid radius grooves in accordance with ANSI/AWWA C-606
- Fittings conform to ANSI 21.10/AWWA C-110 for center-to-end dimensions and AWWA C-153 or ANSI 21.10/AWWA C-110 for wall thicknesses
- Available with a wide variety of coatings and linings
- Victaulic® can supply tapped fittings that meet ANSI B16.1 dimension locations; specify fitting size, tap location by letter on order
- Sizes from 3–36" | 80–900 mm
- Pressure rated up to 350 psi | 2400 kPa



**No. 20-C**  
Tee

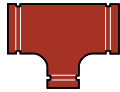

**No. 25-C**  
Reducing Tee



**No. 21-C**  
Bullhead Tee

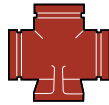

**No. 20-CB**  
Base Tee

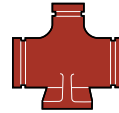

**No. 25-CB**  
Reducing  
Base Tee

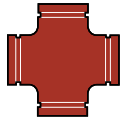

**No. 35-C**  
Cross

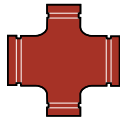

**No. 35-CR**  
Reducing Cross



**No. 33-C**  
True Wye

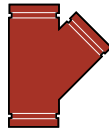

**No. 30-C**  
45° Lateral

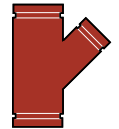

**No. 30-CR**  
45° Reducing  
Lateral



**No. 60-C**  
Cap



## AWWA — Reducers, Flares, Outlets

[Download submittal 23.05](#) for complete information

- AWWA size fittings are supplied with rigid radius grooves in accordance with ANSI/AWWA C-606
- Fittings conform to ANSI 21.10/AWWA C-110 for center-to-end dimensions and AWWA C-153 or ANSI 21.10/AWWA C-110 for wall thicknesses
- Available with a wide variety of coatings and linings
- Victaulic® can supply tapped fittings that meet ANSI B16.1 dimension locations; specify fitting size, tap location by letter on order
- Sizes from 3–36" | 80–900 mm
- Pressure rated up to 350 psi | 2400 kPa



**No. 50-C**  
Concentric Reducer



**No. 51-C**  
Eccentric Reducer



**No. 10-CF**  
90° Flare



**No. 43-CF**  
Straight Flare

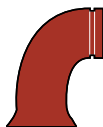

**No. 100-CF**  
90° Long Radius Flare



**No. 20-CS**  
Tee Side Outlet



**No. 10-CS**  
90° Side Outlet



## Check Valve for AWWA

SERIES 317

[Download submittal 23.09](#) for complete information

- Conforms to AWWA C-508 requirements for water and wastewater treatment services
- Sizes from 3–12" | 80–300 mm
- Pressures up to 175 psi | 1200 kPa



## Vic-Plug® Valve for AWWA

SERIES 365

[Download submittal 23.06](#) for complete information





- Conforms to AWWA C-509 standard for end-to-end dimensions
- Round port provides better flow and allows easier passage of cleaning pigs
- Sizes from 3–12" | 80–300 mm
- Pressures up to 175 psi | 1200 kPa

## Hydronic Balancing Solutions





Victaulic® provides balancing products that allow contractors to improve productivity on the job site and engineers to accurately control building temperatures while optimizing energy efficiency. Balancing valves enhance comfort and cut energy costs through precise control of building temperature. Victaulic® KOIL-KIT™ Coil Packs provide a customizable coil solution delivered to the job site as a pre-connected unit for faster and easier installation.









### Manual Balancing Valves

	Solder End (TA Series 786)	65
	Female Threaded End (TA Series 787)	65
	Male x Female (Series 78K)	65
	Flanged End (TA Series 788)	66
	Grooved End (TA Series 789)	66

### Automatic Balancing Valves







	Female Threaded End (Series 76T)	67
	Female Threaded End with Ball Valve Kit (Series 76B)	67
	Male x Female (Series 76K)	67
	Male x Female with Ball Valve Kit (Series 76V)	68
	Grooved End (Series 76G)	68

### Balancing and Control Valves

	ICSS Low Lead Balancing Valve (TA Series 76X)	69
	Terminal Balancing and Control Valve—Female x Female (TA Series TC)	69
	Terminal Balancing Valve for Modulating Control—Female x Female (TA Series TCM)	69
	Pressure Independent Balancing and Control Valve—Female x Female (TA Series TCP)	70
	Combined Balancing and Control Valve—Thread x Thread (TA Series 7FC)	70
	Pressure Independent Modulating Balancing and Control Valve (PIBCV) Thread x Thread (TA Series 7FP)	70





**KOIL-KIT™**

	Coil Pack (Series 799 and 79V)	71
	Coil Pack with ATC and Bypass Options (Series 79B and 79A)	71
	Coil Pack for Air Handling Units (Series 79C and 79D)	72
	Coil Hose	72
	Y-Strainer/Ball Valve Combination (Series 78Y)	73
	Ball Valve/Union Combination (Series 78T)	73
	Union Port Fitting (Series 78U)	73





page

**Differential Pressure Controllers**

	Differential Pressure Controller — Female Threaded End (TA Series 793)	74
	Differential Pressure Controller — Flanged End (TA Series 794)	74

page

**Balancing Instruments**

	Link Differential Pressure Sensor	74
	TA Select Computer Program	75
	CMI Pressure Differential Meter	75
	TA Scope	75

page



## Hydronic Balancing Solutions



### Manual Balancing Valve— Solder End

TA SERIES 786

[Download submittal 08.16](#) for complete information

- “Y” patterned globe valve
- Digital hand wheel with 4 turns to open, 1440 degrees of rotation, and memory stop
- Sizes from ½–2" | 15–50 mm
- Pressures up to 300 psi | 2065 kPa



### Manual Balancing Valve— Female Threaded End

TA SERIES 787

[Download submittal 08.16](#) for complete information

- “Y” patterned globe valve
- Digital hand wheel with 4 turns to open, 1440 degrees of rotation, and memory stop
- Sizes from ½–2" | 15–50 mm
- Pressures up to 300 psi | 2065 kPa



### Manual Balancing Valve— Male x Female

SERIES 78K

[Download submittal 08.16](#) for complete information

- “Y” patterned globe valve with a union adapter
- Digital hand wheel with 4 defined points and unlimited balancing positions
- Sizes from ½–2" | 15–50 mm
- Pressures up to 300 psi | 2065 kPa
- Optional tailpieces available for reductions

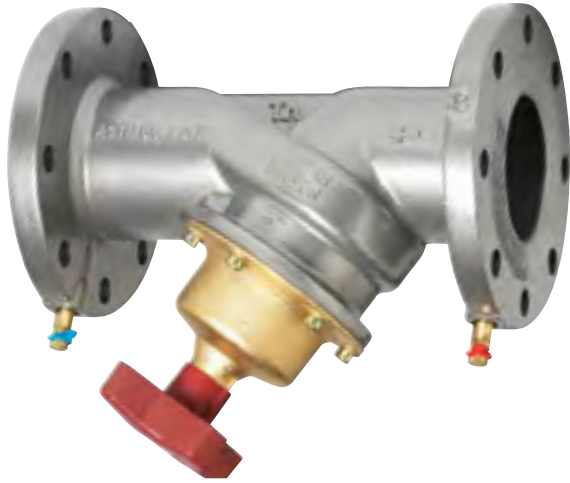

## Manual Balancing Valve— Flanged End

TA SERIES 788

[Download submittal 08.16](#) for complete information

- “Y” patterned globe valve
- Digital hand wheel with 8, 12, or 16 turns to open (depending on size), 1440 degrees of rotation, and memory stop
- Class 150 RF, ASME/ANSI B16.42
- Sizes from 2½–16" | 65–400 mm
- Pressures up to 250 psi | 1725 kPa



## Manual Balancing Valve— Grooved End

TA SERIES 789

[Download submittal 08.16](#) for complete information

- “Y” patterned globe valve
- Digital hand wheel with 8, 12, or 16 turns to open (depending on size), 1440 degrees of rotation, and memory stop
- Sizes from 2½–12" | 65–300 mm
- Pressures up to 350 psi | 2400 kPa



## Automatic Balancing Valve— Female Threaded End

SERIES 76T

[Download submittal 08.34](#) for complete information

- Contains a Victaulic® automatic cartridge with a replaceable orifice plate, specify cartridge type when ordering
- Sizes ½–2" | 15–50 mm, pressure class 365 psi | PN25
- Differential pressure range dependant upon cartridge selected
- Rated from -4°F to 250°F | -20°C to 120°C
- DZR Brass body with an EPDM O-Ring and NPT thread
- Available with optional sweat adapters



## Automatic Balancing Valve with Ball Valve Kit— Female Threaded End

SERIES 76B

[Download submittal 08.34](#) for complete information

- Contains a Victaulic® automatic cartridge with a replaceable orifice plate, specify cartridge type when ordering
- Sizes ½–2" | 15–50 mm, pressure class 365 psi | PN25
- Differential pressure range dependant upon cartridge selected
- Rated from -4°F to 250°F | -20°C to 120°C
- DZR Brass body with an EPDM O-Ring and NPT thread



## Automatic Balancing Valve— Male x Female

SERIES 76K

[Download submittal 08.34](#) for complete information

- Contains a Victaulic® automatic cartridge with a replaceable orifice plate, specify cartridge type when ordering
- Sizes ½–2" | 15–50 mm, pressure class 365 psi | PN25
- Differential pressure range dependant upon cartridge selected
- Rated from -4°F to 250°F | -20°C to 120°C
- DZR Brass body with an EPDM O-Ring and NPT thread
- Available with optional union and sweat adapter



## Automatic Balancing Valve with Ball Valve Kit — Male x Female

SERIES 76V

[Download submittal 08.34](#) for complete information

- Contains a Victaulic® automatic cartridge with a replaceable orifice plate, specify cartridge type when ordering
- Sizes ½–2" | 15–50 mm, pressure class 365 psi | PN25
- Differential pressure range dependant upon cartridge selected
- Rated from -4°F to 250°F | -20°C to 120°C
- DZR Brass body with an EPDM O-Ring and NPT thread



## Automatic Balancing Valve — Grooved End

SERIES 76G

[Download submittal 08.34](#) for complete information

- Size 2½–6" | 65–150 mm
- 365 psi | 2516 kPa
- With integrated PT ports and orifice plate to verify flow

## Hydronic Balancing Solutions



### ICSS Low Lead Balancing Valve

TA SERIES 76X

[Download submittal 08.51](#) for complete information

- NSF Certified in accordance with ANSI/NSF 61 to 180°F | 82°C and ANSI/NSF 372
- Used in drinking water applications
- Sizes ½–1" | 15–25 mm
- Differential pressures 2–32 psi | 13–220 kPa and 5–60 psi | 34–414 kPa



### Terminal Balancing and Control Valve—Female x Female

TA SERIES TC

[Download submittal 08.38](#) for complete information

- Designed for on/off control
- Ensures accurate hydronic control and optimum throughput over a long lifetime
- Sizes ½–1" | 15–25 mm
- Pressures up to 230 psi | 1585 kPa
- For sizes 1¼–6" | 32–150 mm, see pg. 70 for TA Series 7FC



### Terminal Balancing Valve for Modulating Control—Female x Female

TA SERIES TCM

[Download submittal 08.38](#) for complete information

- Designed for modulating control
- Ensures accurate hydronic control and optimum throughput over a long lifetime
- Sizes ½–¾" | 15–20 mm
- Pressures up to 230 psi | 1585 kPa





## Pressure Independent Modulating Balancing and Control Valve (PIBCV)—Female x Female

TA SERIES TCP

[Download submittal 08.39](#) for complete information

- Pressure independent, balancing and control valve
- Ensures accurate hydronic control and optimum throughput over a long lifetime
- Sizes ½–1" | 15–25 mm
- Pressures up to 230 psi | 1585 kPa
- For sizes 1¼–6" | 32–150 mm, see pg. 70 for TA Series 7FP



## Combined Balancing and Control Valve — Thread x Thread

TA SERIES 7FC

[Download submittal 08.52](#) for complete information

- Measures flow, differential pressure, temperature and differential pressure
- EQM characteristics (Equal Percentage Modified)
- 1¼–2" | 32–50 mm Female NPT Threads  
230 psi | 1585 kPa
- 2½–6" | 65–150 mm ANSI Class 150 Flange  
365 psi | 2516 kPa
- For sizes ½–1" | 15–25 mm, see pg. 69 for TA Series TC



## Pressure Independent Combined Balancing and Control Valve — Thread x Thread TA SERIES 7FP

[Download submittal 08.53](#) for complete information

- Pressure independent, balancing and control valve
- Measures flow, differential pressure, temperature and differential pressure
- EQM characteristics (Equal Percentage Modified)
- 1¼–2" | 32–50 mm Female NPT Threads  
230 psi | 1585 kPa
- 2½–6" | 65–150 mm ANSI Class 150 Flange  
365 psi | 2516 kPa
- For sizes ½–1" | 15–25 mm, see TA Series TCP

## Hydronic Balancing Solutions

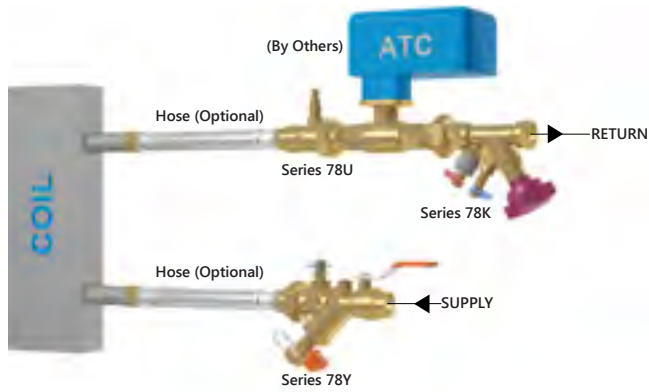

### KOIL-KIT™ Coil Pack

SERIES 799 and SERIES 79V

[Download submittal 08.30](#) for complete information

- Sizes ½–2" | 15–50 mm
- The Series 799 consists of the following components: Series 78Y Y-strainer/ball valve or Series 78T ball valve union combination, two coil hoses, a Series 78U union port fitting, and a balancing valve
- The Series 79V includes the option to have the ATC valve of your choice assembled and shipped with the Victaulic® KOIL-KIT™ coil pack
- Suitable for a variety of hot and cold water applications including treated and untreated water systems

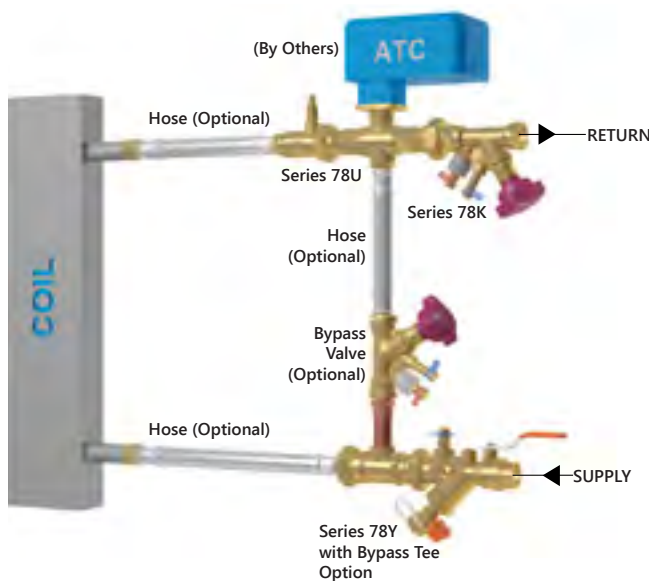

### KOIL-KIT™ Coil Pack with ATC and Bypass Options

SERIES 79B and SERIES 79A

[Download submittal 08.30](#) for complete information

- Sizes ½–2" | 15–50 mm
- The Series 79B consists of the following components in addition to the bypass option: Series 78Y Y-strainer/ball valve or Series 78T ball valve union combination, two coil hoses, a Series 78U union port fitting, and a balancing valve
- The Series 79A includes option to have the ATC valve of your choice assembled and shipped with the Victaulic® KOIL-KIT™ coil pack
- Suitable for a variety of hot and cold water applications including treated and untreated water systems



## KOIL-KIT™ Coil Pack for Air Handling Units

SERIES 79C and SERIES 79D

[Download submittal 08.35](#) for complete information

- Sizes 2½–6" | 65–300 mm
- The Series 79C consists of the following components: Series 732 strainer with a blow down drain valve and a balancing valve
- The Series 79D includes the option of adding a Style 925 drain/air vent assembly included with the Victaulic® KOIL-KIT™ coil pack
- The Style 925 is provided with a Style 107 QuickVic® rigid coupling which is used for connecting the Style 925 to the balancing valve



## KOIL-KIT™ Coil Hose

[Download submittal 08.30](#) for complete information

- Sizes ½–2" | 15–50 mm
- 375 psi | 2585 kPa maximum CWP (varies by size)
- Suitable for operating temperatures up to 230°F | 110°C
- Stainless steel braided hose and a synthetic polymer core with stainless ferrules; available as male by female swivel and male by male swivel
- Available lengths:  
12" | 300 mm; 24" | 600 mm; 36" | 900 mm.



## KOIL-KIT™ Y-Strainer/Ball Valve Combination

SERIES 78Y

[Download submittal 08.30](#) for complete information

- Sizes ½–2" | 15–50mm
- 400 psi | 2758 kPa maximum CWP
- Suitable for operating temperatures up to 230°F | 110°C
- Available as sweat × sweat; sweat × female; sweat × male; female × sweat; female × female; female × male
- DZR brass body consisting of a full port valve and strainer with flow measuring ports



## KOIL-KIT™ Ball Valve/Union Combination

SERIES 78T

[Download submittal 08.30](#) for complete information

- Sizes ½–2" | 15–50mm
- 400 psi | 2758 kPa maximum CWP
- Suitable for operating temperatures up to 230°F | 110°C
- Available as sweat × sweat; sweat × female; sweat × male; female × sweat; female × female; female × male
- A full port valve and strainer with flow measuring ports



## KOIL-KIT™ Union Port Fitting

SERIES 78U

[Download submittal 08.30](#) for complete information

- Sizes ½–2" | 15–50mm
- 400 psi | 2758 kPa maximum CWP
- Suitable for operating temperatures up to 230°F | 110°C
- Available as sweat × sweat; sweat × female; sweat × male; female × sweat; female × female; female × male



## Differential Pressure Controller— Female Threaded End

TA SERIES 793

[Download submittal 08.29](#) for complete information

- Features Ametal®\* body providing dielectric protection
- Sizes ½–2" | 15–50 mm
- Capable of stabilizing differential pressure ranges of 1.5–8.7 psi | 10–60 kPa, 2.9–11.6 psi | 20–80 kPa and 5.8–23.3 psi | 40–160 kPa depending on the controller series, size and spring option

\* AMETAL® is a registered material to TA Hydronics



## Differential Pressure Controller— Flanged End

TA SERIES 794

[Download submittal 08.29](#) for complete information

- Features a ductile iron body
- Sizes 2½–4" | 65–100 mm
- Capable of stabilizing differential pressure ranges of 1.5–8.7 psi | 10–60 kPa, 2.9–11.6 psi | 20–80 kPa and 5.8–23.3 psi | 40–160 kPa depending on the controller series, size and spring option



## Link Differential Pressure Sensor

TA SERIES 736

[Download submittal 08.16](#) for complete information

- Provides connection between a building's heating and cooling and building's monitoring system (BMS)
- Continuously measures the flow and differential pressure through and across the Tour & Andersson balancing valves
- Measurement probes provided for direct connection to the measurement points on all TA Series 786, 787, 788, and 789 balancing valves



## Hydronic Balancing Solutions



### TA Select Computer Program

[Download submittal 08.16](#) for complete information

- The software will advise the correct combination of valve, handwheel position and pipe size to correctly balance the system
- The program will also size the pipe, generate  $C_v$  |  $K_v$  values for the ATC valves and give pre-set information for all TA valves on the project



### CMI Pressure Differential Meter

TA SERIES 73M

[Download submittal 08.16](#) for complete information

- A handheld instrument for measuring differential pressure, temperature and flow through balancing valves in hydronic systems
- Consists of a sensor unit and an instrument unit programmed with the TA valve characteristics, which makes it possible to take a direct reading of flow and differential pressure



### TA Scope

TA SERIES 734

[Download submittal 08.16](#) for complete information

- A wireless, handheld device for the swift and accurate measurement of differential pressure, flow, temperature and power
- An independent sensor communicates with the TA Scope to deliver data quickly, thereby enabling contractors to balance a system, troubleshoot hydronic problems and log system performance



## HDPE Systems

The Victaulic® HDPE system provides easy incorporation of standard IPS fittings and valves directly to HDPE pipe using the HDPE-to-grooved transition. The Victaulic® system permits more accurate estimates and assures on-time modification and future retrofit. Unique mechanical features permit a wide variety of applications for most HDPE piping systems. It combines the advantages of fast installation, design integrity and reliable operation.





### Couplings

page

### Adapters

page

-  Plain End Coupling for HDPE Pipe (Style 995N) 77
-  HDPE to Steel Transition Coupling (Style 997) 78

-  Vic-Flange® Plain End Adapter for HDPE Pipe (Style 994) 78



## Plain End Coupling for HDPE Pipe STYLE 995N

[Download submittal 19.02](#) for complete information

- Coupling teeth create 360° grip of HDPE pipe for secure seal
- Sizes from 2–20" | 50–500 mm
- Pressure rating conforms to the maximum rating of the pipe
- For coating options, download product submittal

### Approvals/Listings:





## HDPE to Steel Transition Coupling

STYLE 997

[Download submittal 19.03](#) for complete information

- Fastest way to join HDPE to IPS pipe
- Sizes from 2–12" | 50–300 mm
- Pressure rating conforms to the maximum rating of the pipe
- For coating options, download product submittal

### Approvals/Listings:



## Vic-Flange® Plain End Adapter for HDPE Pipe

STYLE 994

[Download submittal 19.04](#) for complete information

- Permits direct connection of ANSI Class 125 and 150 flange components into HDPE systems
- Sizes from 4–8" | 100–200 mm
- Pressure rating conforms to the maximum rating of the pipe
- For coating options, download product submittal

### Approvals/Listings:



## Aquamine® PVC System

Victaulic® Aquamine® Reusable PVC piping system offers a complete line of high impact, resistant, reusable pipe, fittings, valves and specialty items. This product line is ideal for a wide variety of water services due to its high impact resistant PVC pipe and synthetic rubber o-rings that provide chemical resistance. The spline assembly used in Victaulic® Aquamine® PVC piping uniquely engages into the grooves of both the coupling and the pipe. The thickened pipe end provides joint reinforcement and security.



### Couplings

	Aquamine® Plain End Coupling (Series 2970)	79
	Aquamine® Transition Coupling for PVC to HDPE (Series 2971)	80
	Aquamine® Transition Coupling for PVC to Groove (Series 2972)	80

page

### Fittings and Pipe

	Aquamine® Fittings	81
	Aquamine® Pipe (Series 2900)	82

page

### Valves

	Aquamine® Ball Valve (Series 2921)	82
	Aquamine® Butterfly Valve (Series 2950)	82

page



## Aquamine® Plain End Coupling

SERIES 2970

[Download submittal 50.01](#) for complete information

- Repair coupling for PVC systems; no pipe preparation required
- Sizes from 2–8" | 50–200 mm
- Pressures up to 350 psi | 2400 kPa





## Aquamine® Transition Coupling for PVC to HDPE

SERIES 2971

[Download submittal 50.05](#) for complete information

- Provides convenient transition from PVC to HDPE without need for special adapters
- Sizes from 2–8" | 50–200 mm
- Pressures up to 350 psi | 2400 kPa



## Aquamine® Transition Coupling for PVC to Groove

SERIES 2972

[Download submittal 50.06](#) for complete information

- Provides convenient transition from PVC to grooved steel without need for special adapters
- Sizes from 2–8" | 50–200 mm
- Pressures up to 350 psi | 2400 kPa

## Aquamine® PVC System



## Aquamine® Fittings

[Download submittal 50.01](#) for complete information

- Variety of straight and reducing fittings including:
- Sizes from 2–12" | 50–300 mm
- Pressures up to 350 psi | 2400 kPa



**Series 2904**  
Coupling  
(ALF x ALF)



**Series 2905**  
Coupling  
(ALF x SCF)



**Series 2906**  
Coupling  
(ALM x PEM)



**Series 2907**  
Coupling  
(ALM x VIC)



**Series 2908**  
Coupling  
(ALM x NPT-M)



**Series 2909**  
Coupling  
(PEM x NPT-M)

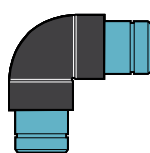

**Series 2910**  
90° Elbow  
(ALM x ALM)



**Series 2912**  
45° Long  
(ALM x ALM)

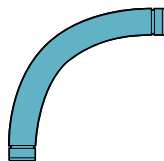

**Series 2913**  
90° Sweep  
(ALM x ALM)

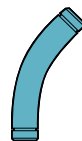

**Series 2914**  
45° Sweep  
(ALM x ALM)



**Series 2915**  
End Cap  
(ALM)

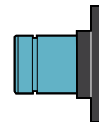

**Series 2916**  
Transition  
Nipple  
(ALM x FLG)

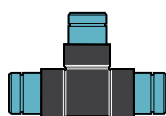

**Series 2917**  
Tee  
(ALM x ALM x ALM)

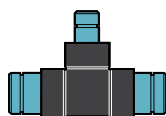

**Series 2918**  
Reducing Tee  
(ALM x ALM x ALM)



**Series 2919**  
Reducer  
(ALF x ALM)



**Series 2920**  
Reducer  
(ALM x SCF)



**Series 2930**  
Outlet Coupling  
(ALF x ALF x NPT-F)



**Series 2937** (1" | 25 mm Outlet)  
**Series 2938** (1½" | 32 mm Outlet)  
**Series 2939** (2" | 50 mm Outlet)  
Formed Outlet Coupling  
(NPT-F x NPT-F x NPT-F)



**Series 2940**  
Outlet Fitting  
(ALM x ALM x NPT-F)

### Connection Key

**ALF** Female End  
**ALM** Male End  
**FLG** Flange End  
**SCF** Solvent Cement Female End  
**PEM** Plain End Male  
**VIC** Victaulic® Standard Groove End  
**NPT-F** National Pipe Taper Thread Female  
**NPT-M** National Pipe Taper Thread Male



## Aquamine® PVC Pipe

SERIES 2900

[Download submittal 50.01](#) for complete information

- PVC 1120 Type 1, grade 1 (class 12454) conforming to ASTM D-1784 and ASTM D-2241
- Sizes from 2 – 12" | 50 – 300 mm
- Pressures up to 350 psi | 2400 kPa
- For Aquamine® grooving tools, see pg. 104



## Aquamine® Ball Valve

SERIES 2921

[Download submittal 50.01](#) for complete information

- Available with a lever handle or a square nut
- Sizes from 2–6" | 50–150 mm
- Pressures up to 100 psi | 700 kPa



## Aquamine® Butterfly Valve

SERIES 2950

[Download submittal 50.01](#) for complete information

- Provided with a lever handle for easy on-off operation
- Sizes from 2–6" | 50–150 mm
- Pressures up to 250 psi | 1725 kPa

## Grooved PVC System

Before the Victaulic® groove system, joining PVC pipe was time consuming and difficult. Weather conditions and curing times delayed the completion of glued or solvent cement joined PVC systems.

Victaulic® groove products assemble PVC pipe joints in a matter of minutes. A groove can be roll or cut grooved into the PVC pipe. Mechanical couplings require just two bolts and nuts and are used to join the pipe ends while also providing a union at every joint.

The following Victaulic® products may also be used on PVC pipe. Refer to the individual product submittals for additional information.

- [Style 75 Flexible Coupling](#)
- [Style 77 Flexible Coupling](#)
- [Style 78 Snap Joint Coupling](#)
- [Style 791 Boltless Coupling](#)
- [Style 741 Flange Adapter](#)
- [Style 743 Flange Adapter](#)
- [Style HP-70 Rigid Coupling](#)



## Composite Flexible Coupling

### STYLE 171

[Download submittal 06.22](#) for complete information

- For use where corrosive conditions exist
- Designed for use on reverse osmosis systems
- For use on roll/cut grooved PVC
- For stainless steel and FRP applications, contact Victaulic®
- Sizes from 1½–4" | 40–100 mm
- Pressures up to 150 psi | 1034 kPa

## FRP System

The Victaulic® fiberglass-reinforced plastic piping solution offers more efficient installations and is ideal for most applications that currently use butt and wrap to join FRP pipe. The Style 296-A is rated for pressures up to 150 psi | 1035 kPa and the FlushSeal® gasket ensures a smooth flow path.

The Style 296-A is used on a wide variety of applications. Pipe ends are built-up to accommodate AGS grooves that are used to engage the coupling on the pipe.



## Coupling for Fiberglass Reinforced Plastic Pipe

STYLE 296-A

[Download submittal 90.01](#) for complete information

- Designed to create a rigid pipe joint without any special tools while maintaining existing support requirements
- Can be installed in any weather
- No curing time required
- Sizes from 1 – 12" | 25 – 300 mm
- Pressures up to 150 psi | 1035 kPa



## Pipe Preparation Tools







Victaulic® is the world's leading developer of pipe preparation tools. These tools simplify pipe end preparation and are available for pipe sizes ranging from ½" | 15 mm up to 72" | 1825 mm.

Victaulic® tools are available for manual use, field use and fab shop environments. As with our pipe joining technologies, Victaulic® tools make pipe end preparation faster, easier and safer.







Additionally, Victaulic® offers plastic groovers, hole cutting, pipe cut-off, pressing tools, VBSP closure tools and a variety of accessories.



### Field Portable Roll Grooving Tools

	page
 VE12	87
 VE26	87
 VE26/46 Power Drive Kit	88
 VE46	88
 VE226	89
 VE226 Power Drive Kit	89





### Field Fabrication Roll Grooving Tools

	page
 VE106/VE107	90
 VE272SFS	91
 VE270FSD/VE271FSD	92
 VE416FS	93
 VE416FSD/VE417FSD	94
 VE450FSD	95

### Plant/Shop Fabrication Roll Grooving Tools

	page
 VE268	96
 VE414MC	97
 VE460	98
 VE872	99

### Field Manual and Motorized Cut Grooving Tools

	page
 VG28GD, VG28GD-ABR, VDG26GD	100
 VG824, VG824DG, VG824-ABR, VG828	101
 VG	102
 VG412	102

### Plastic Groovers

	page
 VPG26	103
 VPG824	103



**Aquamine® Grooving Tools**



APG

page

104

**Hole Cutting Tools**



HCT908

page

104



VHCT900

105



VIC-TAP® II

105

**Hole Cut-Off Tools**



VCT1 Manual

page

106



VCT2 Automatic

106

**Vic-Press® Tools**



PFT510

page

107

**Tool Accessories**



VPD752

page

107



Power Mule II

108



VAPS112

108



VAPS224

109



VAPS1672

109



PT100A/PT102

110



Tool Carry Bag

110

**VBSP Closure Tools**



Manual VBSP Closure Tools

page

111



Hydraulic VBSP Closure Tools

111

**Fabrication Cell**



VAP131

page

112



VAPS 131R

112



VAPS 131F

113



VAPS 131T

113

## Pipe Preparation Tools



Tool Ratings — Maximum Capacity <sup>1</sup>

Model	Pipe Material	Pipe Size (in   mm)/Schedule				
		¾ 20	1 25	1¼ 32	1½ 40	2 50
VE12	Steel	5-10		5-40		
	Stainless	40S				
	Aluminum <sup>2</sup>	5-10		5-40		
	PVC Plastic	40				
VE12SS	Lt. Wall SS	5S-10S				

<sup>1</sup> Indicates pipe size capacity. For wall thickness capacity and general tool ratings see separate Vic-Easy® Tool Rating Data by [downloading submittal 24.01](#).

<sup>2</sup> 6061-T4 or 6063-T4 alloy must be used.

## Field Portable Roll Grooving Tools

### VE12 GROOVE IN-PLACE

[Download submittal 24.01](#) for complete information

- Tool is manually operated using the supplied ratchet handle
- Enhanced tracking rolls allow bi-directional grooving
- Power Requirements: None
- Weight: 17 lbs. | 8 kg

## Field Portable Roll Grooving Tools

### VE26 GROOVE IN-PLACE

[Download submittal 24.01](#) for complete information

- Tool is manually operated using the supplied ratchet handle
- Enhanced tracking rolls allow bi-directional grooving
- Optional power drive adapter kit available to alternately groove pipe using a Ridgid\* 300 power drive or VPD752
- Power Requirements: None
- Weight: 22 lbs. | 10 kg

\* Ridgid is a registered trademark of the Ridge Tool Company



Tool Ratings — Maximum Capacity <sup>1</sup>

Model	Pipe Material	Pipe Size (in   mm)/Schedule					
		2 50	2½ 60	3 80	4 100	5 125	6 150
VE26S	Steel	5-40		5-10			
	Stainless	40S Only					
VE26C	Copper	K, L, M and DWV					
VE26P	Aluminum <sup>2</sup>	5-40		5-10			
	PVC Plastic	40					
VE26SS	Lt. Wall SS	5S-10S					

<sup>1</sup> Indicates pipe size capacity. For wall thickness capacity and general tool ratings see separate Vic-Easy® Tool Rating Data by [downloading submittal 24.01](#).

<sup>2</sup> 6061-T4 or 6063-T4 alloy must be used.



## Field Portable Roll Grooving Tools

### VE26/46 POWER DRIVE KIT

[Download submittal 24.01](#) for complete information

- Available to allow both tools to be directly mounted to either a Victaulic® VPD752 or Ridgid\* 300 Power Drive
- Newer tools with serial numbers ending in “C” are compatible with the Power Drive Kit; tools which do not contain the “C” suffix will require retrofit to accept the Power Drive Kit; contact Victaulic® for details
- Weight: 7 lbs. | 3 kg

\* Ridgid is a registered trademark of the Ridge Tool Company



## Field Portable Roll Grooving Tools

### VE46 GROOVE IN-PLACE

[Download submittal 24.01](#) for complete information

- Tool is manually operated using the supplied ratchet handle
- Enhanced tracking rolls allow bi-directional grooving and helps to hold the tool on the pipe end during the roll grooving process
- Optional power drive adapter kit available to alternately groove pipe using a Ridgid\* 300 Power Drive or VPD752
- Power Requirements: None
- Weight: 28 lbs. | 13 kg

\* Ridgid is a registered trademark of the Ridge Tool Company

Tool Ratings — Maximum Capacity <sup>1</sup>

Model	Pipe Material	Pipe Size (in   mm)/Schedule				
		3½ 90	4 100	4½ 120	5 125	6 150
VE46S	Steel	5 – 40				
	Stainless	40S Only				
VE46P	Aluminum <sup>2</sup>	5 – 40				
	PVC Plastic	40				

<sup>1</sup> Indicates pipe size capacity. For wall thickness capacity and general tool ratings see separate Vic-Easy® Tool Rating Data by [downloading submittal 24.01](#).

<sup>2</sup> 6061-T4 or 6063-T4 alloy must be used.

## Pipe Preparation Tools



## Field Portable Roll Grooving Tools

### VE226 PORTABLE GROOVER

[Download submittal 24.01](#) for complete information

- Tool is operated using a standard 3/8"/9.5 mm square ratchet drive (not included)
- Drive Requirements: Mounts to Victaulic® VPD752 or Ridgid\* 300 Power Drive; optional bases available
- Weight: 37 lbs. | 17 kg

\* Ridgid is a registered trademark of the Ridge Tool Company

Tool Ratings — Maximum Capacity <sup>1</sup>		Pipe Size (in   mm)/Schedule											
		¾ 20	1 25	1¼ 32	1½ 40	2 50	2½ 60	3 80	3½ 90	4 100	4½ 120	5 125	6 150
VE226S	Steel					5-40			5-10				
	Stainless					40S Only							
VE226B	Steel	5-40											
	Stainless	40S Only											
	Aluminum <sup>2</sup>	5-40											
	PVC Plastic	40											
VE226M	Steel					5-40				5-10			
	Stainless					40S Only							
VE226C	Copper					K, L, M and DWV							
VE226BSS	Lt. Wall SS	5S-10S											
VE226MSS	Lt. Wall SS					5S-10S							
VE226P	Aluminum <sup>2</sup>					5-40				5-10			
	PVC Plastic					40							

<sup>1</sup> Indicates pipe size capacity. For wall thickness capacity and general tool ratings see separate Vic-Easy® Tool Rating Data by [downloading submittal 24.01](#).

<sup>2</sup> 6061-T4 or 6063-T4 alloy must be used.



## Field Portable Roll Grooving Tools

### VE226 POWER DRIVE KIT

[Download submittal 24.01](#) for complete information

- Kit for connecting a VE226 roll grooving tool to a Ridgid\* 700 Power Drive
- Weight: 75 lbs. | 34 kg

\* Ridgid is a registered trademark of the Ridge Tool Company



## Field Fabrication Roll Grooving Tools

### VE106/VE107 GROOVE-N-GO

[Download submittal 24.01](#) for complete information



- Mobile light-duty roll grooving tool with an integral motor/drive unit mounted to portable hand truck
- Reduces pipe handling by allowing the tool to be wheeled directly to the pipe preparation site
- 3/8" | 9.5 mm square ratchet drive for operation (standard)
- Enhanced tracking rolls help to keep the pipe on the tool during the roll grooving process
- Completely self-contained unit with an integral motor, safety foot switch and power plug
- Power Requirements:  
VE106 is provided with 110 volt, 15 amp power;  
VE107 is provided with 220 volt, 6 amp power
- Weight: 140 lbs. | 64 kg

Tool Ratings — Maximum Capacity <sup>1</sup>		Pipe Size (in   mm)/Schedule								
Model	Pipe Material	1¼ 32	1½ 40	2 50	2½ 60	3 80	3½ 90	4 100	5 125	6 150
VE106/VE107	Steel <sup>2,3</sup>	5 – 40								
	Stainless <sup>2</sup>	40S								
	Lt. Wall SS <sup>4</sup>	5S – 10S								
	Copper <sup>5</sup>	K, L, M and DWV								

<sup>1</sup> Indicates pipe size capacity. For wall thickness capacity and general tool ratings see separate Vic-Easy® Tool Rating Data by [downloading submittal 24.01](#).

<sup>2</sup> Use standard grooving rolls marked with the prefix R.

<sup>3</sup> EndSeal® grooving rolls marked with the prefix RZ are available. Contact Victaulic® for details.

<sup>4</sup> Use grooving rolls marked with the prefix RX.

<sup>5</sup> Use grooving rolls marked with the prefix RR.

## Pipe Preparation Tools



## Field Fabrication Roll Grooving Tools

VE272SFS

[Download submittal 24.01](#) for complete information

- Hand pump operation with a unique pivot arm design reduces handle effort
- Enhanced tracking rolls help to keep the pipe on the tool during the roll grooving process
- The fully-motorized, semi-automatic, electrohydraulic tool comes complete with safety guards and safety foot switch
- Power Requirements: Victaulic® VPD752 or Ridgid\* 300 Power Drive
- Weight: 184 lbs. | 84 kg

\* Ridgid is a registered trademark of the Ridge Tool Company

Tool Ratings — Maximum Capacity<sup>1</sup>

Model	Pipe Material	Pipe Size (in   mm)/Schedule													
		¾ 20	1 25	1¼ 32	1½ 40	2 50	2½ 60	3 80	3½ 90	4 100	5 125	6 150	8 200	10 250	12 300
VE272SFS	Steel <sup>2,3</sup>	5-40												5-20	
	Stainless <sup>2</sup>	40S												.250	
	Lt. Wall SS <sup>4</sup>	5S-10S													
	Aluminum <sup>5</sup>	5-40												5-20	
	PVC Plastic <sup>6</sup>	40													
	Copper <sup>7</sup>	K, L, M and DWV													

<sup>1</sup> Indicates pipe size capacity. For wall thickness capacity and general tool ratings see separate Vic-Easy® Tool Rating Data by [downloading submittal 24.01](#).

<sup>2</sup> Use standard grooving rolls marked with the prefix R.

<sup>3</sup> EndSeal® grooving rolls marked with the prefix RZ are available. Contact Victaulic® for details.

<sup>4</sup> Use grooving rolls marked with the prefix RX.

<sup>5</sup> 6061-T4 or 6063-T4 alloy must be used.

<sup>6</sup> Use grooving rolls marked with the prefix RP.

<sup>7</sup> Use grooving rolls marked with the prefix RR.



## Field Fabrication Roll Grooving Tools

VE270FSD/VE271FSD

[Download submittal 24.01](#) for complete information

- Completely self-contained unit with integral gear motor, safety guards, safety foot switch and power cord/plug
- Equipped with a unique pivot arm design, making roll changing quick and easy without removing shafts
- Enhanced tracking rolls help to keep the pipe on the tool during the roll grooving process
- The fully-motorized, semi-automatic, electrohydraulic tool comes complete with safety guards and safety foot switch
- Power Requirements:  
VE270FSD is provided with 110 volt, 15 amp power;  
VE271FSD is provided with 220 volt, 6 amp power
- Weight: 340 lbs. | 154 kg

Tool Ratings — Maximum Capacity <sup>1</sup>		Pipe Size (in   mm)/Schedule													
Model	Pipe Material	¾ 20	1 25	1¼ 32	1½ 40	2 50	2½ 60	3 80	3½ 90	4 100	5 125	6 150	8 200	10 250	12 300
VE270FSD/ VE271FSD	Steel <sup>2,3</sup>	5 – 40												5 – 20	
	Stainless <sup>2</sup>	40S												.250	
	Lt. Wall SS <sup>4</sup>	5S – 10S													
	Aluminum <sup>5</sup>	5 – 40												5 – 20	
	PVC Plastic <sup>6</sup>	40													
	Copper <sup>7</sup>	K, L, M and DWV													

<sup>1</sup> Indicates pipe size capacity. For wall thickness capacity and general tool ratings see separate Vic-Easy® Tool Rating Data by [downloading submittal 24.01](#).

<sup>2</sup> Use standard grooving rolls marked with the prefix R.

<sup>3</sup> EndSeal® grooving rolls marked with the prefix RZ are available. Contact Victaulic® for details.

<sup>4</sup> Use grooving rolls marked with the prefix RX.

<sup>5</sup> 6061-T4 or 6063-T4 alloy must be used.

<sup>6</sup> Use grooving rolls marked with the prefix RP.

<sup>7</sup> Use grooving rolls marked with the prefix RR.



## Field Fabrication Roll Grooving Tools

### VE416FS

[Download submittal 24.01](#) for complete information

- VE416FS is designed for field grooving of OGS pipe and should not be used for continuous field production grooving; For field production grooving capabilities, use a VE450FSD tool, see pg.95
- Equipped with a pipe stabilizer for 6–12" | 50–300 mm pipe sizes to control pipe sway
- Groove depth adjuster allows for easy adjustment for initial groove diameter
- The fully-motorized, semi-automatic, electrohydraulic tool comes complete with safety guards and safety foot switch
- Power Requirements: Victaulic® VPD752 or Ridgid\* 300 Power Drive
- Weight: 240 lbs. | 109 kg

\* Ridgid is a registered trademark of the Ridge Tool Company

Tool Ratings — Maximum Capacity <sup>1</sup>

Model	Pipe Material	Pipe Size (in   mm)/Schedule									
		OGS									
		2 50	2½ 60	3 80	4 100	5 125	6 150	8 200	10 250	12 300	
VE416FS	Steel <sup>2,3</sup>	5–40								10–STD	
	Stainless <sup>2</sup>	40S								STD	
	Lt. Wall SS <sup>4</sup>	5S–10S									
	Aluminum <sup>5,6</sup>	5–40								5–STD	
	PVC Plastic <sup>6</sup>	40									
	Copper <sup>7</sup>	K, L, M and DWV									

<sup>1</sup> Indicates pipe size capacity. For wall thickness capacity and general tool ratings see separate Vic-Easy® Tool Rating Data by [downloading submittal 24.01](#).

<sup>2</sup> Use standard grooving rolls marked with the prefix R.

<sup>3</sup> EndSeal® grooving rolls marked with the prefix RZ are available. Contact Victaulic® for details.

<sup>4</sup> Use grooving rolls marked with the prefix RX.

<sup>5</sup> 6061-T4 or 6063-T4 alloy must be used.

<sup>6</sup> Use grooving rolls marked with the prefix RP.

<sup>7</sup> Use grooving rolls marked with the prefix RR.

## Field Fabrication Roll Grooving Tools

### VE416FSD/VE417FSD

[Download submittal 24.01](#) for complete information



- VE416FSD/VE417FSD is designed for field grooving of OGS pipe and should not be used for continuous field production grooving; For field production grooving capabilities, use a VE450FSD tool, see pg.95
- Groove depth adjuster allows for easy adjustment for initial groove diameter
- Completely self-contained units with integral gear motors, safety foot switch and power cord/plug
- The fully-motorized, semi-automatic, electrohydraulic tool comes complete with safety guards and safety foot switch
- Power Requirements:  
VE416FSD is provided with 110 volt, 15 amp for integral gear motor;  
VE417FSD is provided with 220 volt, 8 amp service
- Weight: 340 lbs. | 154 kg

Tool Ratings — Maximum Capacity <sup>1</sup>		Pipe Size (in   mm)/Schedule									
		OGS									
Model	Pipe Material	2 50	2½ 60	3 80	4 100	5 125	6 150	8 200	10 250	12 300	
VE416FSD/ VE417FSD	Steel <sup>2,3</sup>	5 – 40								10 – STD	
	Stainless <sup>2</sup>	40S									
	Lt. Wall SS <sup>4</sup>	5S – 10S									
	Aluminum <sup>5,6</sup>	5 – 40								5 – STD	
	PVC Plastic <sup>6</sup>	40									
	Copper <sup>7</sup>	K, L, M and DWV									

<sup>1</sup> Indicates pipe size capacity. For wall thickness capacity and general tool ratings see separate Vic-Easy® Tool Rating Data by [downloading submittal 24.01](#).

<sup>2</sup> Use standard grooving rolls marked with the prefix R.

<sup>3</sup> EndSeal® grooving rolls marked with the prefix RZ are available. Contact Victaulic® for details.

<sup>4</sup> Use grooving rolls marked with the prefix RX.

<sup>5</sup> 6061-T4 or 6063-T4 alloy must be used.

<sup>6</sup> Use grooving rolls marked with the prefix RP.

<sup>7</sup> Use grooving rolls marked with the prefix RR.





## Field Fabrication Roll Grooving Tools

### VE450FSD

[Download submittal 24.01](#) for complete information

- The VE450FSD is designed for field production grooving and not continuous fabrication shop production grooving
- Enhanced tracking rolls help to keep the pipe on the tool during the roll grooving process, and quickly change upper roll design
- Lifting point to move the tool using a crane
- Frame can accept most forklifts
- Onboard storage for tool accessories
- Power Requirements: Self-contained unit with two 220 volt, single phase 50/60 hertz, 20 amp integral gear motors to handle heavier loads, safety foot switch and power cord/plug
- Weight: 825 lbs. | 374 kg

#### Tool Ratings — Maximum Capacity<sup>1</sup>

Model	Pipe Material	Pipe Size (in   mm)/Schedule														
		OGS							AGS							
		4 100	5 125	6 150	8 200	10 250	12 300	14 350	16 400	18 450	14 350	16 400	18 450	20 500	22 550	24 600
VE450FSD	Steel <sup>2,3</sup>	5 – 40					5 – STD					5 – STD				
	Stainless <sup>4</sup>	40S							STD			STD				
	Lt. Wall SS <sup>5</sup>	5S – 10S										10S				
	Aluminum <sup>6,7</sup>	5 – 40					STD									
	PVC Plastic <sup>7</sup>	40														

<sup>1</sup> Indicates pipe size capacity. For wall thickness capacity and general tool ratings see separate Vic-Easy® Tool Rating Data by [downloading submittal 24.01](#).

<sup>2</sup> Use standard grooving rolls marked with the prefix R for both OGS and AGS.

<sup>3</sup> EndSeal® grooving rolls marked with the prefix RZ are available. Contact Victaulic® for details.

<sup>4</sup> Use standard grooving rolls marked with the prefix R for OGS and RW for AGS.

<sup>5</sup> Use grooving rolls marked with the prefix RX for OGS and RWX for AGS. (Special RWX Rolls are available for grooving true Sch. 10 (0.250 | 6.4 mm). These rolls are not interchangeable with roll sets from other tool models. Contact Victaulic® for details.

<sup>6</sup> 6061-T4 or 6063-T4 alloy must be used.

<sup>7</sup> Use grooving rolls marked with the prefix RP.

## Plant/Shop Fabrication Roll Grooving Tools

VE268

[Download submittal 24.01](#) for complete information



- The fully-motorized, semi-automatic, electrohydraulic tool comes complete with safety guards and safety foot switch
- Equipped with a unique pivot arm design, making roll changes quick and easy, without removing shafts
- Enhanced tracking rolls help to keep the pipe on the tool during the roll grooving process
- Power Requirements: 220/440 volt, 3-phase, 60 hertz standard; the tool can also be supplied in various voltages, contact Victaulic® for details
- 3-phase requires tool power to be hard wired by a local certified electrician
- Weight: 735 lbs. | 333 kg

Tool Ratings — Maximum Capacity <sup>1</sup>		Pipe Size (in   mm)/Schedule													
Model	Pipe Material	¾ 20	1 25	1¼ 32	1½ 40	2 50	2½ 60	3 80	3½ 90	4 100	5 125	6 150	8 200	10 250	12 300
VE268	Steel <sup>2,3</sup>	5 – 40												5 – 20	
	Stainless <sup>2</sup>	40S													
	Lt. Wall SS <sup>4</sup>	5S – 10S													
	Aluminum <sup>5,6</sup>							5 – 40						5 – 20	
	PVC Plastic <sup>6</sup>							40							
	Copper <sup>7</sup>							K, L, M and DWV							

<sup>1</sup> Indicates pipe size capacity. For wall thickness capacity and general tool ratings see separate Vic-Easy® Tool Rating Data by [downloading submittal 24.01](#).

<sup>2</sup> Use standard grooving rolls marked with the prefix R.

<sup>3</sup> EndSeal® grooving rolls marked with the prefix RZ are available. Contact Victaulic® for details.

<sup>4</sup> Use grooving rolls marked with the prefix RX.

<sup>5</sup> 6061-T4 or 6063-T4 alloy must be used.

<sup>6</sup> Use grooving rolls marked with the prefix RP.

<sup>7</sup> Use grooving rolls marked with the prefix RR.

## Plant/Shop Fabrication Roll Grooving Tools

### VE414MC

[Download submittal 24.01](#) for complete information



- The fully-motorized, semi-automatic, electrohydraulic tool comes complete with safety guards and safety foot switch
- Roll changes are quick and easy, without removing shafts
- Enhanced tracking rolls help to keep the pipe on the tool during the roll grooving process
- Power Requirements: 220/440 volt, 3-phase, 60 hertz standard; the tool can also be supplied in various voltages, contact Victaulic® for details
- 3-phase requires tool power to be hard wired by a local certified electrician
- Weight: 735 lbs. | 333 kg

#### Tool Ratings — Maximum Capacity<sup>1</sup>

Model	Pipe Material	Pipe Size (in   mm)/Schedule											
		OGS										AGS	
		2 50	2½ 60	3 80	4 100	5 125	6 150	8 200	10 250	12 300	14 350	16 400	
VE414MC	Steel <sup>2,3</sup>	5-40								10-STD	10-STD		
	Stainless <sup>4</sup>	40S										STD	
	Lt. Wall SS <sup>5</sup>	5S-10S										5S-10S	
	Aluminum <sup>6,7</sup>	5-40								5-STD			
	PVC Plastic <sup>7</sup>	40											
	Copper <sup>8</sup>	K, L, M and DWV											

<sup>1</sup> Indicates pipe size capacity. For wall thickness capacity and general tool ratings see separate Vic-Easy® Tool Rating Data by [downloading submittal 24.01](#).

<sup>2</sup> Use standard grooving rolls marked with the prefix R for both OGS and AGS.

<sup>3</sup> EndSeal® grooving rolls marked with the prefix RZ are available. Contact Victaulic® for details.

<sup>4</sup> Use standard grooving rolls marked with the prefix R for OGS and RW for AGS.

<sup>5</sup> Use grooving rolls marked with the prefix RX for OGS and RWX for AGS (Special RWX Rolls are available for grooving true Sch. 10 (0.250 | 6.4 mm).

<sup>6</sup> 6061-T4 or 6063-T4 alloy must be used.

<sup>7</sup> Use grooving rolls marked with the prefix RP.

<sup>8</sup> Use grooving rolls marked with the prefix RR.

# Plant/Shop Fabrication Roll Grooving Tools

## VE460

[Download submittal 24.01](#) for complete information



- The fully-motorized, semi-automatic, electrohydraulic tool comes complete with safety guards and safety foot switch
- Enhanced tracking rolls help to keep the pipe on the tool during the roll grooving process
- Support bases are required to groove pipe sizes 26" | 650 mm and larger. Each support base is 12" | 305 mm in height and corresponds with a range of allowable pipe sizes it can groove
- Power Requirements: 220/440 volt, 3-phase, 60 hertz standard; the tool can also be supplied in various voltages, contact Victaulic® for details
- 3-phase requires tool power to be hard wired by a local certified electrician
- Weight: 1500 lbs. | 680 kg

**Tool Ratings — Maximum Capacity <sup>1</sup>**

		Pipe Size (in   mm)/Schedule											
		OGS											
Model	Pipe Material	4 100	5 125	6 150	8 200	10 250	12 300	14 350	16 400	18 450	20 500	22 550	24 600
VE460	Steel <sup>2,3</sup>	5 – 80				5 – XS							
	Stainless <sup>2</sup>	40S				STD							
	Lt. Wall SS <sup>4</sup>	5S – 10S				5S – 10S, TRUE 10							
	Aluminum <sup>5,6</sup>	5 – 40											
	PVC Plastic <sup>6</sup>	40											

**Tool Ratings — Maximum Capacity <sup>1</sup>**

		Pipe Size (in   mm)/Schedule																	
		AGS																	
Model	Pipe Material	14 350	16 400	18 450	20 500	22 550	24 600	26 650	28 700	30 750	32 800	34 850	36 900	38 950	40 1000	42 1050	48 1200	50 1250	60 1500
VE460	Steel <sup>2,3</sup>	10 – XS						.375 – .500 <sup>7</sup>											
	Stainless <sup>2</sup>	STD																	
	Lt. Wall SS <sup>4</sup>	5S – 10S, TRUE 10																	

<sup>1</sup> Indicates pipe size capacity. For wall thickness capacity and general tool ratings see separate Vic-Easy® Tool Rating Data by [downloading submittal 24.01](#).

<sup>2</sup> Use standard grooving rolls marked with the prefix R for OGS and RW for AGS.

<sup>3</sup> EndSeal® grooving rolls marked with the prefix RZ are available. Contact Victaulic® for details.

<sup>4</sup> Use grooving rolls marked with the prefix RX for OGS and RWX for AGS. (Special RWX Rolls are available for grooving true Sch. 10 (0.250 | 6.4 mm). These rolls are not interchangeable with roll sets from other tool models. Contact Victaulic® for details.

<sup>5</sup> 6061-T4 or 6063-T4 alloy must be used.

<sup>6</sup> Use grooving rolls marked with the prefix RP.

<sup>7</sup> API-5L Grade B pipe.



## Plant/Shop Fabrication Roll Grooving Tools

VE872

[Download submittal 24.01](#) for complete information

- The fully-motorized, semi-automatic, electrohydraulic tool comes complete with safety guards and safety foot switch
- Support bases are required to groove 30" | 762 mm and larger pipe sizes; each support base is 16" | 406 mm in height and corresponds with a range of allowable pipe sizes it can groove
- Power Requirements: 220/440 volt, 3-phase, 60 hertz standard; the tool can also be supplied in various voltages, contact Victaulic® for details
- 3-phase requires tool power to be hard wired by a local certified electrician
- Weight: 1900 lbs. | 862 kg

### Tool Ratings — Maximum Capacity

Model	Pipe Material	Pipe Size (in   mm) / Schedule																									
		8 200	10 250	12 300	14 350	16 400	18 450	20 500	22 550	24 600	26 650	28 700	30 750	32 800	34 850	36 900	38 950	40 1000	42 1050	48 1200	50 1250	54 1350	56 1400	60 1500	62 1550	72 1800	
VE872	Carbon Steel	Sch. 40 .500		.375/9.5 mm to .500/12.7 mm <sup>1</sup>																							
	Carbon Steel				.562/.625 wall Grade B Only																						

<sup>1</sup> Physical properties shall be in accordance with API specification 5L, Grades B, X42, X46, X52, X56 or X60, [download publication 25.09](#). For physical properties not listed contact Victaulic® for details.





## Field Manual Cut Grooving Tools

VG28GD (GEAR DRIVE)

VG28GD-ABR (ABRASION)

VDG26GD (DOUBLE GROOVE)

[Download submittal 24.01](#) for complete information

- VG28GD will produce a single OGS cut groove for unlined piping systems
- VG28GD-ABR will produce a single OGS cut groove that allows for lining of the pipe for abrasive services
- VDG26GD will produce a double OGS cut groove for high pressure systems in conjunction with installing the 6" | 150 mm Style 808 couplings
- The VG28GD, VG28GD-ABR and VDG26GD are designed to be driven by the Power Mule II
- Drive Requirements: External drive, min. 1½ hp
- Drive Speed: 38 rpm max.
- Weight: 37 lbs. | 17 kg

Tool Ratings — Maximum Capacity		Pipe Size (in   mm)/Schedule							
		2 50	2½ 65	3 80	3½ 90	4 100	5 125	6 150	8 200
VG28GD <sup>2</sup>	Steel	40 – 80 <sup>1</sup>							
	Stainless	40 – 80 <sup>1</sup>							
	Aluminum	40 – 80 <sup>1</sup>							
	Ductile Iron	Class 53 Min.							
VG28GD-ABR <sup>2</sup>	Steel	40 – 80 <sup>1</sup>							40
VDG26GD <sup>2</sup>	Steel							40 – 80	

<sup>1</sup> 6" | 150 mm Schedule 80

<sup>2</sup> Special knives and stops may be required.

## Pipe Preparation Tools

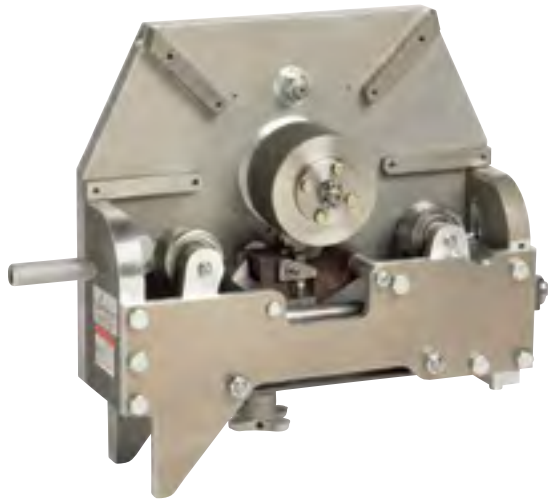

### Tool Ratings —

#### Maximum Capacity

Model	Pipe Material	Pipe Size (in   mm)/Schedule									
		8 200	10 250	12 300	14 350	16 400	18 450	20 500	22 550	24 600	
VG824 <sup>1</sup>	Steel	40-80				30-STD					
	Stainless	30-STD									
	Aluminum	30-STD									
	Ductile Iron	Class 53 Min.									
VG824DG <sup>1</sup>	Steel	40-80									
VG824-ABR <sup>1</sup>	Steel	40-XS									

<sup>1</sup> Special knives and stops may be required.

## Field Manual Cut Grooving Tools

VG824 (OGS)

VG824-ABR (ABRASION OGS)

VG824DG (DOUBLE GROOVE)

[Download submittal 24.01](#) for complete information

- VG824 will produce a single OGS cut groove for unlined piping systems
- VG824-ABR will produce a single OGS cut groove that allows for lining of the pipe for abrasive services
- VG824DG will produce a double OGS cut groove for high pressure piping systems in conjunction with installing Style 808 couplings
- The VG824, VG824DG and VG824-ABR are designed to be driven by the Power Mule II
- Drive Requirements: External drive, min. 1½ hp
- Drive Speed: 38 rpm max.
- Weight: 82 lbs. | 37.2 kg

## Field Manual Cut Grooving Tools

VG828 (AGS)

[Download submittal 24.01](#) for complete information

- VG828 will produce a single AGS cut groove
- The VG828 is designed to be driven by the Power Mule II
- Drive Requirements: External drive, min. 1½ hp
- Drive Speed: 38 rpm max.
- Weight: 82 lbs. | 37.2 kg



### Tool Ratings — Maximum Capacity

Model	Pipe Material	Pipe Size (in   mm)/Schedule						
		14 350	16 400	18 450	20 500	22 550	24 600	
VG828 <sup>1</sup>	Steel	.500-.750						

<sup>1</sup> Special knives and stops may be required.



## Field Cut Grooving Tools

### VG VIC®-GROOVER

[Download submittal 24.01](#) for complete information

- Designed for manual or power cut grooving
- Supplied with a ratchet handle for manual operation
- Drive Requirements: Manual or external drive, min. ½ hp | 0.37 kw
- External power drives must meet all safety conditions
- Drive Speed: 40 rpm max.
- Weight: 28 lbs. | 13 kg

Tool Ratings — Maximum Capacity <sup>1</sup>		Pipe Size (in   mm)/Schedule											
Model	Pipe Material	¾ 20	1 25	1¼ 32	1½ 40	2 50	2½ 60	3 80	3½ 90	4 100	5 125	6 150	8 200
VG	Steel	40–80											
	Stainless	40–80											
	Aluminum <sup>2</sup>	40–80											
	PVC Plastic	40–80											
	Ductile Iron											Cl. 53	Class 53 Min.

<sup>1</sup> Indicates pipe size capacity. For wall thickness capacity and general tool ratings see separate Vic-Easy® Tool Rating Data by [downloading submittal 24.01](#).

<sup>2</sup> 6061-T4 or 6063-T4 alloy must be used.



## Field Motorized Cut Grooving Tools

### VG412 ORBITAL MACHINING TOOL

[Download submittal 24.01](#) for complete information

- Specifically designed for field closure pieces (not suitable for production grooving)
- External mounting and drive action is particularly suited to cement lined ductile iron pipe grooving
- Hinged frame design allows cutting at any point along the pipeline
- Drive Requirements: 120 volt, 11.5 amp
- Weight: 151 lbs. | 69 kg

Tool Ratings — Maximum Capacity		Pipe Size (in   mm)/Schedule							
Model	Pipe Material	4 100	4½ 120	5 125	6 150	8 200	10 250	12 300	
VG412	Steel	40–80							
	Ductile Iron	Class 53 Min.							

## Pipe Preparation Tools



### Plastic Groovers

#### VPG26

[Download submittal 24.01](#) for complete information

- Features a high speed, router-type tool bit which cuts a radial groove, to full depth, in one manual rotation of the tool around the pipe
- Rotation Drive: Manual (clockwise)
- Power Requirements: 110 volt, single phase, 60 hertz, 7 amp
- Weight: 41 lbs. | 19 kg

Tool Ratings — Maximum Capacity		Pipe Size (in   mm)/Schedule						
Model	Pipe Material	2 50	2½ 60	3 80	3½ 90	4 100	5 125	6 150
VPG26	PVC Plastic	40–80						

### Plastic Groovers

#### VPG824

[Download submittal 24.01](#) for complete information

- Features a high speed, router-type tool bit which cuts a radial groove, to full depth, in one manual rotation of the tool around the pipe
- Rotation Drive: Manual (Clockwise)
- Power Requirements: 110 volt, single phase, 60 hertz, 7 amp
- Weight: 47 lbs. | 21 kg



Tool Ratings — Maximum Capacity		Pipe Size (in   mm)/Schedule				
Model	Pipe Material	8 200	10 250	12 300	14 350	16 400
VPG824	PVC Plastic	40–80				

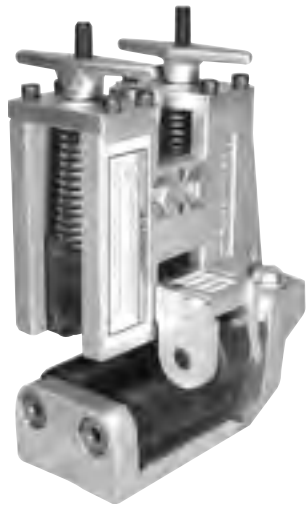

## Aquamine® Grooving Tools

APG

[Download submittal 24.01](#) for complete information

- Manually operated tool used for producing a cut spline groove and beveled end on Aquamine® PVC pipe
- Prepares 4–12" | 100–300 mm Aquamine® pipe to receive an Aquamine® coupling
- Orbital tool which is rotated around a stationary, secured pipe
- May be operated on pipe held in a pipe vise or on supported in-place piping that is depressurized and drained
- Weight: 13 lbs. | 5.9 kg



## Hole Cutting Tools

HCT908

[Download submittal 24.01](#) for complete information

- One-piece hole cutting tool designed to cut holes up to 4½" | 120 mm in carbon and stainless steel pipe; for pipe sizes up to 8" | 200 mm
- Allows use of Mechanical-T®, Vic-Let®, and Vic-O-Well outlets
- Power Requirements: 110 volt, single phase, 60 hertz, 7 amp
- Weight: 23 lbs. | 10 kg



## Pipe Preparation Tools



### Hole Cutting Tools

#### VHCT900

[Download submittal 24.01](#) for complete information

- Three-piece hole cutting tool designed to cut holes up to 3½" | 90 mm in diameter for Mechanical-T®, Vic-Let®, and Vic-O-Well® outlets
- Base unit clamps quickly onto the pipe in vertical, horizontal or overhead positions
- Available extended chain for 10–24" | 250–600 mm pipe
- Power Requirements: Grounded 120volt, single phase, 60 hertz, 10 amp electrical supply (220 volt, single phase, 60 hertz, 5 amp available on request)
- Weight: 36 lbs. | 16 kg



### Hole Cutting Tools

#### VIC-TAP® II

[Download submittal 24.01](#) for complete information

- Hole cutting tool including Style 931 Vic-Tap® II Mechanical-T® unit for tapping into steel pipe systems under pressure up to 500 psi | 3450 kPa
- Hole size 2¾" | 60.5 mm
- Power Requirements: 115 volt, single phase, 60 hertz, 7.5 amp
- Weight:  
Drill guide base: 15 lbs. | 6.8 kg; Drill motor and feed assembly: 16 lbs. | 7.3 kg; Style 931/Valve unit, 12–15 lbs. | 5.4–6.8 kg, depending upon size (4, 5, 6 and 8" | 100, 125, 150, 200 mm available)
- Standard Capability: 4–8" | 100–200 mm Run outlet only × 2½" | 65 mm (IPS) Outlet



## Pipe Cut-Off Tools

### VCT1 MANUAL

[Download submittal 24.01](#) for complete information

- Lightweight and portable pipe cut-off tool handles 4–24" | 100–600 mm pipe, up to 0.5" | 12.7 mm thick
- Worm gear drive crank handle provides smooth, manual travel, easy control and accurate cutting
- Wall thickness: 0.065–0.500" | 1.65–12.7 mm (with tips supplied)
- Tips: Acetylene–1 ea. #00, #0, #1
- Power Requirements: NA
- Weight: 22 lbs. | 10 kg



## Pipe Cut-Off Tools

### VCT2 AUTOMATIC

[Download submittal 24.01](#) for complete information

- Rotation is powered by a small 120VAC motor with SCR remote control
- Unique distributor design has stainless steel insert which extends tip life, eases cleaning and reduces backfire
- Wall thickness: 0.065–0.500" | 1.65–12.7 mm (with tips supplied)
- Tips: Acetylene–1 ea. #00, #0, #1
- Motor rating: 15W, 10,000 rpm
- Power requirements: 120 volt, single phase, 60 hertz, 15 amp
- Weight: 33 lbs. | 15 kg

## Pipe Preparation Tools



## Vic-Press® Tools

### PFT510

[Download submittal 24.01](#) for complete information

- Designed for securing Vic-Press® Schedule 10S products onto Schedule 10S stainless steel pipe
- Tool package includes:
  - (1) PFT510 tool,
  - (2) 18V Lithium Ion batteries,
  - (1) battery charger,
  - (1) tool carrying case,
  - (1) jaw carrying case,
  - (1) each of jaws sized ½" | 15 mm, ¾" | 20 mm, 1" | 25 mm, 1½" | 40 mm, and 2" | 50 mm, and
  - (1) adapter jaw
- Not compatible with PFT505 and/or PFT509 tools/components
- Power Requirements: Battery pack 110volt, 60cycle, 6.5 amp (optional 220volt)
- Weight: 21 lbs. | 9.5 kg  
(PFT510 with 1" | 25 mm jaw)



## Tool Accessories

### VPD752 POWER DRIVE

[Download submittal 24.01](#) for complete information

- Can be used as the power drive unit for the VE226, VE26, VE206, VE46, VE416FS and VE272SFS roll grooving tools provided each tool is equipped with the correct base plate and the VG, VG28GD, and VG824 tools, with universal drive shaft
- Operated with a safety foot switch
- Power Requirements: 115 volts, 15 amp, 50/60 hertz (220 volt, 6 amp, 50/60 cycle option)
- Weight: 140 lbs. | 634 kg



## Tool Accessories

### POWER MULE II

[Download submittal 24.01](#) for complete information

- Ideal for driving individual Victaulic® cut grooving tools
- Heavy-duty, two wheeled unit drives Victaulic® cut grooving tools at the speed/power necessary for accurate grooving
- Rotating head for horizontal and vertical applications
- Power Mule II equipped with forward-off-reverse control and integral safety foot switch
- Full load speed: 35 rpm
- Power Requirements: 115 volts, 15 amp, 50/60 cycle (220 volts optional)
- Weight: 190 lbs. | 86 kg



## Tool Accessories

### VAPS112 ADJUSTABLE PIPE STAND

[Download submittal 24.01](#) for complete information

- Designed for supporting pipe to be roll grooved
- Turnstile design allows pipe to be spun around for grooving of both pipe ends without dismounting pipe from stand
- Forward/traverse movement
- Capacity: ¾ – 12" | 20–300 mm IPS pipe
- Load rating: 1,075 lbs. | 490 kg
- Vertical stroke: 14½" | 368 mm for adjusting rod, 8½" | 216 mm leg adjustment 23" | 584 mm
- Minimum pipe height from floor: 23" | 584 mm on 12" | 300 mm pipe and 21" | 533 mm on 1" | 25 mm pipe
- Weight: 190 lbs. | 86 kg

## Pipe Preparation Tools



### Tool Accessories

#### VAPS224 ADJUSTABLE PIPE STAND

[Download submittal 24.01](#) for complete information

- Designed specifically for supporting pipe to be roll grooved
- Self-standing, heavy-duty unit permits free pipe rotation and traversing on ball transfers
- Capacity: 2–24" | 50–600 mm IPS pipe
- Load rating: 1,800 lbs. | 816 kg
- Vertical stroke: 23" | 584 mm
- Minimum pipe height from floor 13" | 325 mm on 24" | 600 mm IPS pipe
- Maximum pipe height from floor 38" | 965 mm on 2" | 50 mm IPS pipe
- Weight: 260 lbs. | 118 kg



### Tool Accessories

#### VAPS1672 ADJUSTABLE PIPE STAND

[Download submittal 24.01](#) for complete information

- Designed specifically for supporting pipe to be roll grooved
- Self-standing, heavy duty unit permits free pipe rotation and traversing on ball transfers
- Designed for use with VE436MC and VE460 tools
- Capacity: 16–72" | 400–1800 mm IPS pipe
- Load rating: 10,000 lbs. | 4535 kg
- Vertical Stroke 17" | 425 mm
- Minimum pipe height from floor 16" | 400 mm on 72" | 1800 mm pipe
- Maximum pipe height from floor 28" | 700 mm on 16" | 400 mm pipe
- Weight: 480 lbs. | 218 kg





## Tool Accessories

### PT100A AND PT102

[Download submittal 24.01](#) for complete information

- Go/No-Go, pocket-sized steel tapes for taking circumferential measurements of pipe
- Go/No-Go side can be used to check cut or roll grooved pipe for conformance to Victaulic® grooved specifications
- Tapes notched on the lead end to allow proper overlap within the groove for more accurate measurement
- PT100A contains Go/No-Go markings for use with  $\frac{3}{4}$ –24" | 20–600 mm pipe; tape marked with 0.01" | 0.25 mm increments on the opposite side
- PT102 contains Go/No-Go markings for use with Original Groove System sizes 8–12" | 200–300 mm and Advanced Groove System sizes 14–72" | 350–1800 mm; tape marked in 0.02" | 0.5 mm increments on the opposite side
- Go/No-Go side of tapes may not be used to measure cast iron, ductile iron, or copper tube sizes



## Tool Accessories

### TOOL CARRY BAG

[Download submittal 24.01](#) for complete information

- Heavy duty tool carry bag for transporting roll grooving tools, grooving rolls, and other tool accessories
- Carry bag can accommodate up to 50 lbs. | 23 kg
- Weight: 4 lbs. | 2 kg

## Pipe Preparation Tools



## Manual Victaulic® Bolted Split-Sleeve Products (VBSP) Closure Tools

CTM-01 SMALL MANUAL TOOL  
CTM-02 LARGE MANUAL TOOL

[Download submittal 24.01](#) for complete information

- Offered in small and large sizes and is ideal for joining select VBSP couplings
- The tool brings the coupling housings together to allow the bolts and nuts to be installed
- For specific information on the appropriate tool by coupling, please download individual coupling product submittals



## Hydraulic VBSP Closure Tools

CTH-01 SMALL 10-TON HYDRAULIC TOOL  
CTH-02 LARGE 25-TON HYDRAULIC TOOL

[Download submittal 24.01](#) for complete information

- The CTH-01 hydraulic tool can be used on many of the VBSP couplings
- Applying up to 10 tons of hydraulic force, the CTH-01 makes joining VBSP faster, easier and more reliable
- The CTH-02 hydraulic tool is designed for joining VBSP with a wall thickness of  $\frac{3}{4}$ " | 19 mm or 1" | 25.4 mm
- Exerting over 25 tons of pressure, the tool is the fastest, safest and easiest way to assemble any Type 3 VBSP
- For specific information on the appropriate tool by coupling, please download individual coupling product submittals

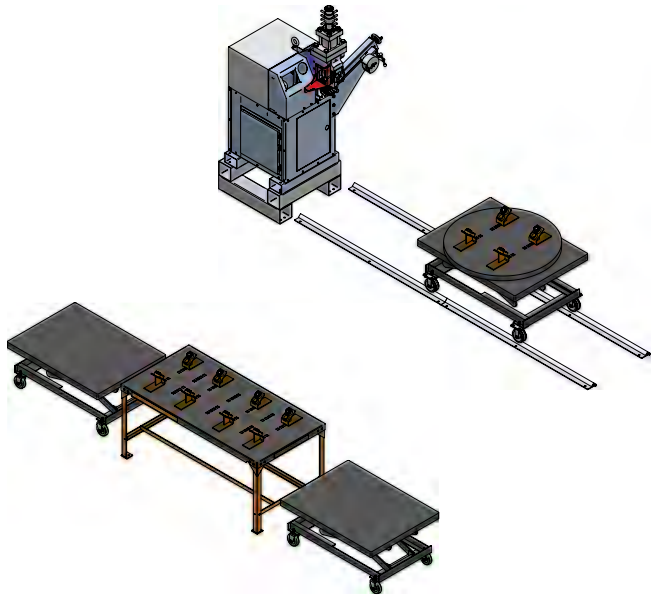

## Fabrication Cell

VAP131

[Download submittal 24.01](#) for complete information

- Turn-key, fab-shop solution
- Maximize productivity gains associated with Victaulic® grooved systems
- Includes hydraulic adjustable pipe stand and tracks, tool support, two adjustable positioner tables, an assembly table, as well as caster wheels and ball transfers



## Fabrication Cell

VAPS 131R HYDRAULIC ADJUSTABLE PIPE STAND

[Download submittal 24.01](#) for complete information

- Designed to support pipe for roll grooving
- Permits free pipe rotation and traversing on ball transfers
- Turnstile design allows pipe to be spun around for grooving of both pipe ends without dismantling from pipe stand
- Capacity: 4–24" | 100–600 mm IPS pipe; load rating: 2000 lbs. | 907 kg
- Vertical stroke: 30.5" | 775 mm
- Minimum pipe height from floor: Compatible with Victaulic® production roll grooving tools
- Power Requirements: 115 VAC
- Weight: 500 lbs. | 227 kg

## Pipe Preparation Tools



### Fabrication Cell

#### VAPS 131F HYDRAULIC POSITIONER

[Download submittal 24.01](#) for complete information

- Designed to support grooved pipe, valves, and fittings when used in conjunction with the VAPS 131T Assembly Table
- Foot control provided for hands-free operation
- Swivel caster wheel design for better mobility
- Capacity: 4–24" | 100–600 mm IPS pipe; load rating: 1200 lbs. | 544 kg with wheels installed, 2000 lbs. | 907 kg without wheels
- Vertical stroke: 29.25" | 743 mm
- Power Requirements: 115 VAC
- Weight: 400 lbs. | 181 kg



### Fabrication Cell

#### VAPS 131T ASSEMBLY TABLE

[Download submittal 24.01](#) for complete information

- Designed to support grooved pipe, valves, and fittings when used in conjunction with VAPS 131F Hydraulic Positioner
- Ball transfer assemblies can be positioned to accommodate pipe from 2–24" | 50–600 mm
- Capacity: 4–24" | 100–600 mm IPS pipe; load rating: 8000 lbs. | 3629 kg, ball transfers load rating 700 lbs. | 318 kg
- Vertical stroke: 29.25" | 743 mm
- Weight: 500 lbs. | 227 kg





## Elastomer Gasket Seals

Victaulic® offers a broad variety of synthetic rubber gaskets suitable for a wide range of applications. Victaulic® gaskets provide high- and low-temperature limits, tensile strength, chemical resistance and shelf life.



Installation-Ready™



Standard



Reducing

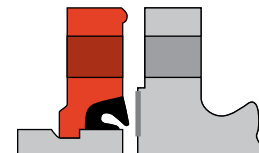

Vic-Flange®

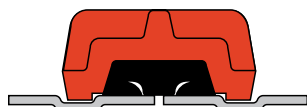

FlushSeal®

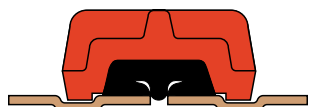

Grooved Copper Tubing with FlushSeal® Gasket



Advanced Groove System (AGS)



EndSeal®

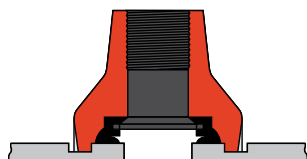

Outlet



Mechanical-T®



IPS to AWWA Transition



AWWA FlushSeal®



Plain End



Plain End Piping System for HDPE Pipe

unpressed  
Vic-Press® for Schedule 10S Stainless Steel  
pressed

Victaulic® Bolted Split-Sleeve Products (VBSP)



FRP

Intro
OGS
AGS
VBSB
Hole Cut
Expansion Joints
Plain End
Stainless Steel
Copper
AWWA
Hydraulic Balancing
HDPE
Aquamine® PVC
Grooved PVC
FRP
Tools
<b>Gaskets/Seals/O-Rings</b>
Design Data
Index

## Elastomer Gasket Seals

### Gasket Materials

Victaulic® offers a wide variety of synthetic rubber gaskets for a broad range of applications. For most water applications, the Victaulic® Grade “E” EPDM (ethylene propylene diene monomer) gasket compound is compatible. Victaulic® Grade “E” material has premium performance properties with respect to aging and resistance to heat and hot water. Heat aging tests at +250°F | +121°C conducted on this material show essentially no change in physical properties. This situation is further enhanced when this rubber is subjected to an essentially non-oxidative environment, such as a gasket in a water piping system. For example, aging tests in a non-oxidative atmosphere show essentially no change in physical properties of this material even when tested at temperatures up to +350°F | +177°C.

Since water has no deteriorating effect on the elastomer, temperature is the only limiting factor to be considered in determining the life expectancy of the elastomer in water service. The superior performance of the Grade “E” elastomer permits its use for hot water service up to +230°F | +110°C. The Grade “E” gasket is superior to previous gasket materials by all performance barometers, including high and low temperature limits, tensile strength, chemical resistance and shelf life.

### Gasket/Seal/O-Ring Data

Victaulic® offers a variety of synthetic rubber gaskets/seals/o-rings for the widest range of applications. To assure the maximum life for the service intended, proper gasket selection and specification in ordering is essential. The foremost consideration is temperature, along with concentration of product, duration of service and continuity of service. Temperatures beyond the compatibility limits have a degrading effect on the polymer.

Services listed are General Service Guidelines only. It should be noted that there are services for which these gaskets/seals/o-rings are not compatible. Reference should always be made to the latest Gasket Chemical Services Guide ([download publication GSG-100](#)) for specific service guidelines and for a listing of services which are not compatible.

Gasket guidelines apply only to Victaulic® gaskets, seals and o-rings. Guidelines for a particular service do not necessarily imply compatibility of the coupling housing, related fittings or other components for the same service.

These guidelines do not apply to rubber-lined or rubber seal valves or other rubber-lined products. Victaulic® gaskets are clearly marked as part of the mold with the gasket size, style and compound for easy identification.

### Potable Water Listings and Classifications

Grade “E” EPDM, Grade “E” Vic-Plus™, Grade “E2”, Grade “EHP” and Grade “EHP” Vic-Plus™ gaskets are UL Classified in accordance with ANSI/NSF 61 for cold (+86°F | +30°C) and hot (+180°F | +82°C) potable water service and ANSI/NSF 372. [Download publication 02.06](#) for more details.

Victaulic® Grade “M” halogenated butyl gasket material (which is typically used with our AWWA sized products) is UL Classified in accordance with ANSI/NSF 61 for cold (+86°F | +30°C) potable water service and ANSI/NSF 372. [Download publication 02.06](#) for more details.

Vic-Press® Schedule 10S couplings and fittings: UL Classified in accordance with ANSI/NSF 61 for cold +73°F | +23°C and hot +180°F | +82°C potable water service with “E” and “H” o-rings and ANSI/NSF 372. [Download publication 02.06](#) for more details.

In addition to the above, the standard black asphalt coating used on our cement lined AWWA size fittings is NSF 61 Listed. As the coating is the only material that comes in contact with the water, NSF 61 compliant coatings are commercially available and may be applied to our products. For more details about Victaulic® gasket construction and testing, [download submittal 05.01](#).

### Gasket Lubricant

Thorough lubrication of the gasket exterior, including the lips and/or pipe ends and housing interiors, is essential for proper installation. Use Victaulic® Lubricant for installation. Other compatible material, such as silicone and others may be used on Grades “E” or “L” gaskets. Victaulic® Lubricant is available in a box of (12) 4 fluid ounce | 114 milliliter tubes or in 1 quart | 946 milliliters containers.

**Important Note:** Victaulic® Lubricant is not compatible for use with high-density polyethylene (HDPE) pipe.

ALWAYS USE LUBRICANT FOR PROPER COUPLING ASSEMBLY.

### Valve Seals

Victaulic® Gasket Selection Guide (05.01) does not include Victaulic® seals for valves. Refer to the individual Victaulic® valve submittal for information on the seals available for each valve.

## Elastomer Gasket Seals

**WARNING**

- To assure maximum life for the service intended, proper gasket selection and specification in ordering is essential. For specific chemical and temperature compatibility, refer to the Gasket Selection and Chemical Services sections. The information shown defines general ranges for all compatible fluids.

Failure to select the proper rubber compound may result in personal injury or property damage, improper installation, joint leakage or joint failure.

## Standard Gaskets—IPS

Grade <sup>1</sup>	Temp. Range <sup>1</sup>	Compound	Color Code	General Service Guidelines
<b>E</b>	-30°F to +230°F -34° C to +110° C	EPDM	Green Stripe	May be specified for hot water service within the specified temperature range plus a variety of dilute acids, oil-free air and many chemical services. UL Classified in accordance with ANSI/NSF 61 for cold +73°F   +23°C and hot +180°F   +82°C potable water service and ANSI/NSF 372. <b>NOT COMPATIBLE FOR USE WITH PETROLEUM SERVICES.</b>
<b>EHP<sup>2</sup></b>	-30°F to +250°F -34°C to +120°C	EPDM	Red and Green Stripes	May be specified for hot water service within the specified temperature range. UL Classified in accordance with ANSI/NSF 61 for cold +73°F   +23°C and hot +180°F   +82°C potable water service and ANSI/NSF 372. <b>NOT COMPATIBLE FOR USE WITH PETROLEUM SERVICES.</b>
<b>T</b>	-20°F to +180°F -29° C to +82° C	Nitrile	Orange Stripe	May be specified for petroleum products, hydrocarbons, air with oil vapors, vegetable and mineral oils within the specified temperature range. <b>Not compatible for use with hot, dry air over +140°F   +60°C and water over +150°F   +66°C.</b> <b>NOT COMPATIBLE FOR USE WITH HOT WATER SERVICES.</b>
<b>E</b> (Type A) <sup>3</sup>	Ambient	EPDM	Violet Stripe	Applicable for wet and dry (oil-free air) sprinkler services only. For dry services FlushSeal® gaskets may be specified. <b>NOT COMPATIBLE FOR USE WITH HOT WATER SERVICES.</b>
<b>E2</b>	Ambient	EPDM	Double Green Stripe	UL Classified in accordance with ANSI/NSF 61 for cold +73°F   +23°C and hot +180°F   +82°C potable water service and ANSI/NSF 372. <b>NOT COMPATIBLE FOR USE WITH PETROLEUM SERVICES.</b>

<sup>1</sup> For specific chemical and temperature compatibility, refer to the [Gasket Selection Guide \(05.01\)](#) which includes the Gasket Chemical Services Short Report or refer to the [Gasket Chemical Services Guide Long Report \(GSG-100\)](#) located on [victaulic.com](http://victaulic.com). The information shown defines general ranges for all compatible fluids.

<sup>2</sup> The Grade EHP gasket is only available on Style 107, 607 and 177 couplings.

<sup>3</sup> Vic-Plus™ pre-lubricated gasket.

## Special Gaskets—IPS

Grade	Temp. Range <sup>1</sup>	Compound	Color Code	General Service Guidelines
<b>M2</b>	-40°F to +160°F -40° C to +71° C	Epichlorohydrin	White Stripe	Specially compounded to provide superior service for common aromatic fuels at low temperatures. Also suitable for certain ambient temperature water services.
<b>V</b>	-30°F to +180°F -34° C to +82° C	Neoprene	Yellow Stripe	May be specified for hot lubricating oils and certain chemicals. Good oxidation resistance. Will not support combustion.
<b>O</b>	+20°F to +300°F -7° C to +149° C	Fluoroelastomer	Blue Stripe	May be specified for many oxidizing acids, petroleum oils, halogenated hydrocarbons, lubricants, hydraulic fluids, organic liquids and air with hydrocarbons. <b>NOT COMPATIBLE FOR USE WITH HOT WATER SERVICES.</b>
<b>L</b>	-30°F to +350°F -34° C to +177° C	Silicone	Red Gasket	May be specified for dry heat, air without hydrocarbons to +350°F   +177°C and certain chemical services.
<b>A</b>	+20°F to +180°F -7° C to +82° C	White Nitrile	White Gasket	No carbon black content. May be used for food. Meets FDA requirements. Conforms to CFR Title 21 Part 177.2600. <b>Not compatible for use with hot, dry air over +140°F   +60°C and water over +150°F   +66°C. NOT COMPATIBLE FOR USE WITH HOT WATER SERVICES.</b>
<b>HMT</b> (T EndSeal®)	-20°F to +150°F -29° C to +66° C	Nitrile	Orange and Silver Stripes	Specially compounded with excellent oil resistance and a high modulus for resistance to extrusion. May be specified for petroleum products, air with oil vapors, vegetable and mineral oils within the specified temperature range. For maximum gasket life under pressure extremes, the temperature should be limited to +120°F   +49°C. <b>NOT COMPATIBLE FOR USE WITH HOT WATER SERVICES OVER +150°F   +66°C OR FOR HOT, DRY AIR OVER +140°F   +60°C.</b>
<b>EF</b>	-30°F to +230°F -34° C to +110° C	EPDM	Green "X"	May be specified for hot and cold water service within the specified temperature range plus a variety of dilute acids, oil-free air and many chemical services. Also meets hot and cold potable water requirements per DVGW, KTW, ÖVGW, SVGW and French ACS (Crecep), approved for W534, approved for EN681-1 Type WA cold potable and Type WB hot potable water service. <b>NOT COMPATIBLE FOR USE WITH PETROLEUM SERVICES.</b>
<b>EW</b>	-30°F to +230°F -34° C to +110° C	EPDM	Green "W"	May be specified for hot water service within the specified temperature range plus a variety of dilute acids, oil-free air and many chemical services. WRAS approved material to BS 6920 for cold and hot potable water service up to +149°F   +65°C UL Classified in accordance with ANSI/NSF 61 for cold +73°F   +23°C and hot +180°F   +82°C potable water service and ANSI/NSF 372. <b>NOT COMPATIBLE FOR USE WITH PETROLEUM SERVICES.</b>

<sup>1</sup> For specific chemical and temperature compatibility, refer to the [Gasket Selection Guide \(05.01\)](#) which includes the Gasket Chemical Services Short Report or refer to the [Gasket Chemical Services Guide Long Report \(GSG-100\)](#) located on [victaulic.com](http://victaulic.com). The information shown defines general ranges for all compatible fluids.

## Elastomer Gasket Seals

## AWWA Coupling Gaskets

Grade	Temp. Range <sup>1</sup>	Compound	Color Code	General Service Guidelines
<b>S</b>	-20° F to +180° F -29° C to +82° C	Nitrile	Orange Stripe	Specially compounded to conform to ductile pipe surfaces. May be specified for petroleum products, air with oil vapors, vegetable and mineral oils within the specified temperature range. <b>Not compatible for use with hot, dry air over +140° F   +60° C and water over +150° F   +66° C.</b> <b>NOT COMPATIBLE FOR USE WITH HOT WATER SERVICES.</b>
<b>M</b>	-20° F to +200° F -29° C to +93° C	Halogenated Butyl	Brown Stripe	May be specified for water service within the specified temperature range plus a variety of dilute acids, oil-free air and many chemical services. Readily conforms to ductile iron pipe surfaces. UL Classified in accordance with ANSI/NSF 61 for cold +86° F   +30° C potable water service and ANSI/NSF 372. <b>NOT COMPATIBLE FOR USE WITH PETROLEUM SERVICES.</b>

<sup>1</sup> For specific chemical and temperature compatibility, refer to the [Gasket Selection Guide \(05.01\)](#) which includes the Gasket Chemical Services Short Report or refer to the [Gasket Chemical Services Guide Long Report \(GSG-100\)](#) located on [victaulic.com](http://victaulic.com). The information shown defines general ranges for all compatible fluids.

## Vic-Press® Seals

Grade	Temp. Range <sup>1</sup>	Compound	Color Code	General Service Guidelines
<b>H</b>	-20° F to +210° F -29° C to +98° C	Hydrogenated Nitrile Butadiene Rubber (HNBR)	Two Orange Stripes	May be specified for hot petroleum/water mixtures, hydrocarbons, air with oil vapors, vegetable and mineral oils, engine oil and transmission oil. UL Classified in accordance with ANSI/NSF 61 for cold +73° F   +23° C and hot +180° F   +82° C potable water service and ANSI/NSF 372.
				Standard Seal: Vic-Press® products will ship with Grade "H" seal unless otherwise specified on order.
<b>E</b>	-30° F to +250° F -34° C to +121° C	EPDM	Green Stripe	May be specified for hot water service, dilute acids, oil-free air, chemical services. UL Classified in accordance with ANSI/NSF 61 for cold +73° F   +23° C and hot +180° F   +82° C potable water service and ANSI/NSF 372. <b>NOT COMPATIBLE FOR USE WITH PETROLEUM OR STEAM SERVICES.</b>
<b>O</b>	+20° F to +300° F +6° C to +149° C	Fluoroelastomer	Blue Stripe	May be specified for oxidizing acids, petroleum oils, halogenated hydrocarbons, lubricants, hydraulic fluids, organic liquids, and air with hydrocarbons. <b>NOT COMPATIBLE FOR USE WITH HOT WATER OR STEAM SERVICES.</b>

<sup>1</sup> For specific chemical and temperature compatibility, refer to the [Gasket Selection Guide \(05.01\)](#) which includes the Gasket Chemical Services Short Report or refer to the [Gasket Chemical Services Guide Long Report \(GSG-100\)](#) located on [victaulic.com](http://victaulic.com). The information shown defines general ranges for all compatible fluids.



## Elastomer Gasket Seals

## VBSP O-rings

Grade	Temp. Range <sup>1</sup>	Compound	Color Code	General Service Guidelines
<b>E</b>	-30°F to +230°F -34°C to +110°C	EPDM	N/A	Cold and hot water within allowable temperature range; dilute acids; excellent resistance to the deteriorative effects of ozone, oxygen, heat and most chemicals not involving hydrocarbons. <b>NOT COMPATIBLE FOR USE WITH PETROLEUM SERVICES.</b>
<b>L</b>	-30°F to +350°F -34°C to +177°C	Silicone	N/A	Dry, hot air applications; excellent resistance to many chemicals. <b>NOT COMPATIBLE FOR USE WITH HOT WATER OR STEAM SERVICES.</b>
<b>I</b>	-40°F to +160°F -40°C to +71°C	Isoprene	N/A	Water; saltwater; sewage; good resistance to oxygen and dilute acids.

<sup>1</sup> For specific chemical and temperature compatibility, refer to the [Gasket Selection Guide \(05.01\)](#) which includes the Gasket Chemical Services Short Report or refer to the [Gasket Chemical Services Guide Long Report \(GSG-100\)](#) located on [victaulic.com](http://victaulic.com). The information shown defines general ranges for all compatible fluids.

## VBSP Gaskets

Grade	Temp. Range <sup>1</sup>	Compound	Color Code	General Service Guidelines
<b>T</b>	-20°F to +180°F -28°C to +82°C	Nitrile	N/A	Water; petroleum products, vegetable and mineral oils; air with oil vapors within allowable temperature.
<b>O</b>	+20°F to +300°F -7°C to +149°C	Fluoroelastomer	N/A	Outstanding resistance to heat and most chemicals.
<b>V</b>	-30°F to +180°F -34°C to +82°C	Neoprene	N/A	Water and wastewater; good resistance to ozone, effects of UV and some oils.

<sup>1</sup> For specific chemical and temperature compatibility, refer to the [Gasket Selection Guide \(05.01\)](#) which includes the Gasket Chemical Services Short Report or refer to the [Gasket Chemical Services Guide Long Report \(GSG-100\)](#) located on [victaulic.com](http://victaulic.com). The information shown defines general ranges for all compatible fluids.

## Design Data

### Introduction

This Victaulic® General Catalog has been written for the piping system installer, designer, specification writer and owner as a basic reference guide for data about Victaulic® mechanical piping methods. This catalog is organized to provide information in the context and form most readily usable. For easy identification of major sections of interest, see the condensed table of contents on pg. i, for a fully detailed index, see pg. 125. For more detailed information, [download Design Data 26.01](#).

### Important Information

Victaulic® standard grooved pipe couplings are designed for use with pipe grooved to meet Victaulic® groove specifications and Victaulic® grooved end fittings, valves, and related grooved end components only. They are not intended for use with plain end pipe and/or fittings. Victaulic® plain end couplings are designed for use only with plain end or beveled end steel pipe (unless otherwise indicated) and Victaulic® plain end fittings. **Victaulic® plain end couplings must not be used with grooved end or threaded end pipe and/or fittings. Nor are they intended for use with Advanced Groove System (AGS) components used on 14–72" | 350–1825 mm pipe sizes.**

Pipe must be prepared to meet Victaulic® specifications outlined for each specific product style. Performance data listed herein is based on proper pipe preparation. The proper gasket must be selected for the service intended. **It should be noted that there are various services for which Victaulic® gaskets are not recommended. Reference should always be made to the latest Victaulic® Gasket Selection Guide ([download submittal 05.01](#)) for specific gasket service recommendations and for a listing of services which are not recommended. Gaskets for Victaulic® products always must be lubricated for proper assembly.**

Gasket lubricant must meet manufacturer's specifications. Thorough lubrication of the gasket exterior, including the lips and/or pipe ends and housing interiors, is essential to prevent gasket pinching. Lubrication assists proper gasket seating and alignment during installation.

Victaulic® has a complete line of tools for preparing pipe to Victaulic® specifications. Use of these tools is recommended in preparing pipe to receive Victaulic® products. Always read and understand the Tool Operating Instructions supplied with every Victaulic® tool prior to using any tools. All data contained herein, is subject to change without notice.

### Notice

The technical and performance data, weights, dimensions and specifications published in this catalog supersede all previously published data.

Victaulic® maintains a policy of continual product improvement and, therefore, reserves the right to change product specifications, designs, and standard equipment without notice and without incurring obligation.

For the most up-to-date Victaulic® product information, please visit [victaulic.com](http://victaulic.com).

The material presented in this catalog is intended for piping design reference in utilization of Victaulic® products for their intended application. It is not intended as a substitute for competent, professional assistance which is an obvious requisite to any specific application.

### Design

Reference should always be made to design information available at no charge on request from Victaulic®. Good piping practices should always prevail. Specific pressures, temperatures, external or internal loads, performance standards and tolerances must never be exceeded. Many applications require recognition of special conditions, code requirements and use of safety factors. Qualified engineers must make these decisions.

While every effort has been made to ensure its accuracy, Victaulic®, its subsidiaries and affiliated companies, make no express or implied warranty of any kind respecting the information contained in this catalog or the material referred to herein.

Anyone making use of the information or material contained herein does so at their own risk and assumes any and all liability resulting from such use.

### Installation

Reference should always be made to the specific Victaulic® Field Installation Handbook for the product you are installing. The following is a list of handbooks that can be requested for free from Victaulic®:

I-100	General Handbook
I-300	AWWA Products Handbook
I-P500	Vic-Press® Handbook
I-600	Copper Products Handbook
I-900	HDPE Products Handbook

Handbooks are included with each shipment of Victaulic® products for complete installation and assembly data, and are available in PDF format on our website at [victaulic.com](http://victaulic.com).

## Design Data

### Global Pipe Size Designations

Victaulic® product data is utilized worldwide and all technical data is shown in both imperial (U.S.) and metric terms. The following chart shows a comparison between typical metric and IPS pipe sizes.

Nominal Imperial Inches – Size Group	Outside Diameter mm/Spec Ref	DIN mm	JIS mm	ANSI inches	China Standard (GB) mm
½	21.3 mm	15	15 A/21.7 mm	½	15*/21.3 mm
¾	26.7 mm	20/26.9 mm	20 A/27.2 mm	¾	20*/26.9 mm
1	33.4 mm	25/33.7 mm	25 A/34 mm	1	25*/33.7 mm
1¼	42.2 mm	32/42.4 mm	32 A/42.7 mm	1 1/4	32*/42.4 mm
1½	48.3 mm	40	40 A/48.6 mm	1 1/2	40*/48.3 mm
2	60.3 mm	DN & ISO 50	50 A/60.5 mm	2	50*/60.3 mm
2½	73.1 mm	—	—	2 ½	—
3	76.1 mm DIN/ISO (3 OD)	DN & ISO 65	65 A/76.3 mm	—	65*/76.1 mm
	88.9 mm	DN & ISO 80	JIS 80 A	3	80*/88.9 mm
4	108 mm China and old DIN	DIN 108 mm	—	—	108 mm
	114.3 mm	DN & ISO 100	JIS 100 A	4	100*/114.3 mm
5	133 mm China and old DIN	DIN 133 mm	—	—	133 mm
	139.7 mm DIN/ISO (5.5 OD)	DN & ISO 125	125 A/139.8 mm	—	125*/139.7 mm
	141.3 mm	—	—	5	—
6	159 mm China and old DIN	DIN 159 mm	—	—	159 mm
	165.1 mm JIS (6.5 OD)	—	150 A/165.2 mm	—	—
	168.3 mm	DN & ISO 150	—	6	150*/168.3 mm
8	216.3 JIS	—	JIS 200 A	—	—
	219.1 mm	DN 200	—	8	219.1 mm
10	267.4 JIS	—	JIS 250 A	—	—
	273 mm	DN 250	—	10	273 mm
12	318.5 JIS	—	JIS 300 A	—	—
	323.9 mm	DN 300	—	12	323.9 mm
14	355.6 mm	DN 350	JIS 350 A	14	355.6 mm
	377 mm China	—	—	—	377 mm
16	406.4 mm	DN 400	JIS 400 A	16	406.4 mm
	426 mm China	—	—	—	426 mm
18	457.2 mm	DN 450	JIS 450 A	18	457.2 mm
	480 mm China	—	—	—	480 mm
20	508 mm	DN 500	JIS 500 A	20	508 mm
	530 mm China	—	—	—	530 mm
22	558.8 mm	—	JIS 550 A	22	559 mm

Continued on next page.

## Design Data

Nominal Imperial Inches – Size Group	Outside Diameter mm/Spec Ref	DIN mm	JIS mm	ANSI inches	China Standard (GB) mm
24	610 mm	DN 600	JIS 600 A	24	610 mm
	630 mm China	—	—	—	630 mm
26	660 mm	—	JIS 650 A	26	660 mm
28	711 mm	DN 700	—	28	711 mm
30	762 mm	—	—	30	762 mm
32	813 mm	DN 800	—	32	813 mm
34	864 mm	—	—	34	864 mm
36	914 mm	DN 900	—	36	914 mm
40	1016 mm	DN 1000	—	40	1016 mm
42	1067 mm	DN 1050	—	42	1067 mm
44	1118 mm	DN 1100	—	44	1118 mm
46	1168 mm	DN 1150	—	46	1168 mm
48	1219 mm	DN 1200	—	48	1219 mm
54	1372 mm	DN 1350	JIS 1372	54	1372 mm
56	1422 mm	DN 1400	JIS 1422	56	1422 mm
60	1524 mm	DN 1500	JIS 1524	60	1524 mm

### GENERAL NOTES:

Nominal designations are used where the actual OD of the pipe matches the ANSI size. Otherwise both the nominal and actual OD are listed. China sizes are listed as actual OD in mm. China sizes in shaded boxes are tubing sizes.

\* Nominal sizes

## Design Data

### Imperial (U.S.)/Metric Conversion Chart

This chart is provided as a guide for converting imperial and metric measurements provided within this catalog.

Convert Imperial (U.S.) to Metric				Convert Metric to Imperial (U.S.)		
25.4	×	Inches (In.)	⇔	Millimeters (mm)	×	0.03937
0.3048	×	Feet (Ft.)	⇔	Meters (m)	×	3.281
0.4536	×	Pounds (Lbs.)	⇔	Kilograms (kg)	×	2.205
28.35	×	Ounces (Oz.)	⇔	Grams (g)	×	0.03527
6.894	×	Pressure (psi)	⇔	Kilopascals (kPa)	×	0.145
0.069	×	Pressure	⇔	Bar	×	14.5
4.45	×	End Load (Lbs.)	⇔	Newtons (N)	×	0.2248
1.356	×	Torque (Lb. Ft.)	⇔	Newton Meters (N•m)	×	0.738
$F - 32 \div 1.8$		Temp.(°F)	⇔	Celsius (°C)		$C + 17.78 \times 1.8$
745.7	×	Horsepower (hp)	⇔	Watts (w)	×	$1.341 \times 10^3$
3.785	×	Gal. per Min. (GPM)	⇔	Liters per Min. (L/M)	×	0.2642
3.785	×	$10^{-3}$ Gal. per Min. (GPM)	⇔	Cubic Meters per Min. (m <sup>3</sup> /m)	×	264.2



## Index

### Original Groove System (OGS)

Ball Valve	17
Brass Body Valve — Threaded	18
Butterfly Valve	14
Composite Flexible Coupling	3
Diverter Valve	16
EndSeal® System	21
Expansion Joint	13
Fittings — Adapters, Nipples, Caps and Plugs	11
Fittings — Elbows	9
Fittings — Reducers	12
Fittings — Tees, Crosses, Wyes and Laterals	10
Flexible Coupling	4
High Pressure Coupling	21
High Pressure Rigid Coupling	6
Mechanical-T® Spigot Assembly	22
Mover® Expansion Joint	13
MTS Plug Valve	19
Outlet Coupling	5
QuickVic® Flexible Coupling	3
QuickVic® Rigid Coupling	3
Reducing Coupling	5
Snap-Joint® Coupling	5
Suction Diffuser	20
Swinger® Swing Check Valve	16
Three Port Diverter	18
Triple Service (Duty) Assemblies	19
Venturi Check Valve	15
Vic-300® MasterSeal™ Butterfly Valve	14
Vic®-Ball Valve	17
Vic-Boltless® Coupling and Tool	6
Vic-Check® Valve	15
Vic-Flange® Adapter	8
Vic-Plug® Valve	18
Vic-Ring® Coupling	7
Vic-Strainer® Tee Type	20
Vic-Strainer® Wye Type	20
XL Couplings for use with XL Fittings	6
XL (Extended Life) System for Rubber-lined Abrasive Services	22
Zero-Flex® Rigid Coupling	4

### Advanced Groove System (AGS)

AGS Butterfly Valve	28
AGS Expansion Joint	28
AGS Fittings	27
AGS Flexible Coupling	25
AGS Rigid Coupling	25
AGS Stainless Steel Rigid Coupling	25
AGS Suction Diffuser	30
AGS Tee Type Vic-Strainer®	30
AGS Triple Service Valve Assembly	29
AGS Vic-300® Butterfly Valve	28
AGS Vic-Check® Dual Disc Valve	29
AGS Vic-Flange® Adapter	26
AGS Vic-Ring® Flexible Coupling	26
AGS Vic-Ring® Rigid Coupling	26
AGS Wye Type Vic-Strainer®	30

### Victaulic® Bolted Split-Sleeve Products (VBSP)

Non-Restrained Flexible Coupling for Carbon Steel Pipe	31
Non-Restrained Flexible Coupling for Stainless Steel Pipe	32
Restrained Flexible Single-Gasket Coupling for Carbon Steel Pipe	32
Restrained Flexible Single-Gasket Coupling for Stainless Steel Pipe	32

### Hole Cut System

Mechanical-T® Outlet	33
Outlet Coupling	34
Vic-Let® Strapless Outlet	34
Vic-O-Well® Strapless Thermometer Outlet	34

### Expansion Joints

AGS Expansion Joint	36
Expansion Joint	36
Expansion Joint Coupling	38
Mover® Expansion Joint	36
Non-Restrained Flexible Expansion Coupling for Carbon Steel Pipe	37
Non-Restrained Flexible Expansion Coupling for Stainless Steel Pipe	37
Stainless Steel Bellow Expansion Joint	39

### Plain End Systems for Carbon Steel

Fittings	42
Roust-A-Bout® Plain End Coupling	41

### Stainless Steel System

ANSI Schedule 10S Fittings	47
ANSI Schedule 40S Fittings	48
Butterfly Valve	49
Duplex Flexible Coupling	45
Duplex Lightweight Flexible Coupling	46
Duplex Rigid Coupling	45
MTS Plug Valve	50
Rigid Coupling	44
Swinger® Check Valve	49
Three-Piece Vic-Press® Ball Valve	50
Type 316 Flexible Coupling	45
Type 316 Lightweight Flexible Coupling	45
Type 316 Rigid Coupling	44
Vic-Ball® Valve	49
Vic-Ball® Valve	50
Vic-Flange® Adapter	46
Vic-Press® For Schedule 10S Stainless Steel Type 304	51
Vic-Press® For Schedule 10S Stainless Steel Type 316	52

### Copper System

Butterfly Valve for Copper	56
Dielectric Waterway Fitting	55
Fittings for Copper Mechanical-T® Bolted Branch Outlet and Cross Assemblies for Copper	56
QuickVic® Rigid Coupling	53
Vic-Flange® Adapter for Copper	54

### AWWA System

Check Valve for AWWA	62
Coupling for AWWA Ductile Iron Pipe	58
Fittings — Elbows	59
Fittings — Reducers, Flares, Outlets	61
Fittings — Tees, Crosses, Wyes, Laterals	60
Transition Coupling for IPS to AWWA	58
Vic-Flange® Adapter for AWWA	58
Vic-Plug® Valve for AWWA	62

**Hydronic Balancing Solutions**

Automatic Balancing Valve— Female Threaded End	67	Pressure Independent Combined Balancing and Control Valve— Thread × Thread	70
Automatic Balancing Valve— Grooved End	68	Pressure Independent Modulating Balancing and Control Valve— Female × Female	70
Automatic Balancing Valve— Male × Female	67	TA Scope	75
Automatic Balancing Valve with Ball Valve Kit— Female Threaded End	67	TA Select Computer Program	75
Automatic Balancing Valve with Ball Valve Kit— Male × Female	68	Terminal Balancing and Control Valve— Female × Female	69
CMI Pressure Differential Meter	75		
Combined Balancing and Control Valve— Thread × Thread	70		
Differential Pressure Controller— Female Threaded End	74		
Differential Pressure Controller— Flanged End	74		
ICSS Low Lead Balancing and Control Valve	69		
KOIL-KIT™ Ball Valve/Union Combination	73		
KOIL-KIT™ Coil Hose	72		
KOIL-KIT™ Coil Pack	71		
KOIL-KIT™ Coil Pack for Air Handling Units	72		
KOIL-KIT™ Coil Pack with ATC and Bypass Options	71		
KOIL-KIT™ Union Port Fitting	73		
KOIL-KIT™ Y-Strainer/Ball Valve Combination	73		
Link Differential Pressure Sensor	74		
Manual Balancing Valve— Female Threaded End	65		
Manual Balancing Valve— Flanged End	66		
Manual Balancing Valve— Grooved End	66		
Manual Balancing Valve— Male × Female	65		
Manual Balancing Valve— Solder End	65		
Modulating Terminal Balancing and Control Valve— Female × Female	69		

**HDPE System**

HDPE to Steel Transition Coupling	78
Plain End Coupling for HDPE Pipe	77
Vic-Flange® Plain End Adapter for HDPE Pipe	78

**Aquamine® PVC System**

Aquamine® Ball Valve	82
Aquamine® Butterfly Valve	82
Aquamine® Fittings	81
Aquamine® Plain End Coupling	79
Aquamine® PVC Pipe	82
Aquamine® Transition Coupling for PVC to Groove	80
Aquamine® Transition Coupling for PVC to HDPE	80

**Grooved PVC System**

Composite Flexible Coupling	83
--------------------------------	----

**FRP System**

Coupling for Fiberglass Reinforced Plastic Pipe	84
--	----

**Pipe Preparation Tools**

APG	104
CTH-01 Small 10-Ton Hydraulic Tool	111
CTH-02 Large 25-Ton Hydraulic Tool	111
CTM-01 Small Manual Tool	111
CTM-02 Large Manual Tool	111
HCT908	104
PFT510	107
Power Mule II	108
PT100A and PT102	110
Tool Carry Bag	110
VAP131	112
VAPS112 Adjustable Pipe Stand	108
VAPS 131F Hydraulic Positioner	113
VAPS 131R Hydraulic Adjustable Pipe Stand	112
VAPS 131T Assembly Table	113
VAPS224 Adjustable Pipe Stand	109
VAPS1672 Adjustable Pipe Stand	109
VCT1 Manual	106
VCT2 Automatic	106
VE12 Groove In-Place	87
VE26/46 Power Drive Kit	88
VE26 Groove In-Place	87
VE46 Groove In-Place	88
VE106/VE107 Groove-N-GO	90
VE226 Portable Groover	89
VE226 Power Drive Kit	89
VE268	96
VE270FSD/VE271FSD	92
VE272SFS	91
VE414MC	97
VE416FS	93
VE416FSD/VE417FSD	94
VE450FSD	95
VE460	98
VE872	99
VG28GD (Gear Drive)	100
VG28GD-ABR (Abrasion)	100
VDG26GD (Double Groove)	100
VG412 Orbital Machining Tool	102

VG824 (OGS)	101
VG824-ABR (Abrasion OGS)	101
VG824DG (Double Groove)	101
VG828 (AGS)	101
VG Vic®-Groover	102
VHCT900	105
Vic-Tap® II	105
VPD752 Power Drive	107
VPG26	103
VPG824	103

**Gaskets**

AWWA Coupling Gaskets	119
Special Gaskets—IPS	118
Standard Gaskets—IPS	117
VBSP Gaskets	120
VBSP O-rings	120
Vic-Press® Seals	119

Intro

OGS

AGS

VBSP

Hole Cut

Expansion Joints

Plain End

Stainless Steel

Copper

AWWA

Hydronic Balancing

HDPE

Aquamine® PVC

Grooved PVC

FRP

Tools

Gaskets/Seals/O-Rings

Design Data

Index

Intro	
OGS	
AGS	
VBSP	
Hole Cut	
Expansion Joints	
Plain End	
Stainless Steel	
Copper	
AWWA	
Hydronic Balancing	
HDPE	
Aquamine® PVC	
Grooved PVC	
FRP	
Tools	
Gaskets/Seals/O-Rings	
Design Data	



## Warranty

---

### WARRANTY:

We warrant all products to be free from defects in materials and workmanship under normal conditions of use and service. Our obligation under this warranty is limited to repairing or replacing at our option at our factory any product which shall within one year after delivery to original buyer be returned with transportation charges prepaid, and which our examination shall show to our satisfaction to have been defective.

THIS WARRANTY IS MADE EXPRESSLY IN LIEU OF ANY OTHER WARRANTIES, EXPRESS OR IMPLIED, INCLUDING ANY IMPLIED WARRANTY OF MERCHANTABILITY OR FITNESS FOR A PARTICULAR PURPOSE. THE BUYER'S SOLE AND EXCLUSIVE REMEDY SHALL BE FOR THE REPAIR OR REPLACEMENT OF DEFECTIVE PRODUCTS AS PROVIDED HEREIN. THE BUYER AGREES THAT NO OTHER REMEDY (INCLUDING, BUT NOT LIMITED TO, INCIDENTAL OR CONSEQUENTIAL DAMAGES FOR LOST PROFITS, LOST SALES, INJURY TO PERSON OR PROPERTY OR ANY OTHER INCIDENTAL OR CONSEQUENTIAL LOSS) SHALL BE AVAILABLE TO HIM.

Victaulic® neither assumes nor authorizes any person to assume for it any other liability in connection with the sale of such products.

**This warranty shall not apply to any product which has been subject to misuse, negligence or accident, which has been repaired or altered in any manner outside of a Victaulic® factory or which has been used in a manner contrary to Victaulic® instructions or recommendations. Victaulic® shall not be responsible for design errors due to inaccurate or incomplete information supplied by Buyer or its representatives.**

Items purchased by Victaulic® and resold will have the original equipment manufacturer's warranty extended to Victaulic® customers.



## PRODUCT CERTIFICATIONS:

## Fire Protection

ACTIVFIRE – ActivFire Register of Fire Protection Equipment (Australia)
CCCF – China Certification Center for Fire Protection Products (China)
CFPSC – Chinese Fire Protection Safety Center (Taiwan)
CNBOP – Centrum Naukowo-Badawcze Ochrony Przeciwpowazarowej (Poland)
CNPP- Centre National de Prévention et de Protection (France)
CTPC – Consiliul Technic Permanent Pentru Constructii (Romania)
cULus – Underwriter's Laboratories, LLC (USA)
EMI – Epitesugyi Minosegellenorzo Innovacious (Hungary)
FDNY – City of New York Fire Department (USA)
FM – FM Approvals (USA)
HDB – Singapore Housing Development Board (Singapore)
KFI – Korea Fire Industry Technology Institute (Korea)
LPCB – Loss Prevention Certification Board (UK)
SBSC – Svensk Brand & S�kerhets Certifiering AB (Sweden)
TFRI – Tanjin Fire Research Institute of Ministry of Public Security (China)
TSU – Technický Sk�sobn�y �stav Piešťany, �.p. (Slovakia)
TSUS – Technický Sk�sobn�y �stav Stavebn�y, n.o. (Slovakia)
TZUS – Technick� a Zkuševní �stav Stavebn� Praha, s.p. (Czech Republic)
UKRFIRESERT – State Certification Center (Ukraine)
UL – Underwriter's Laboratories, LLC (USA)
ULC – Underwriter's Laboratories of Canada (Canada)
VdS – Verband der Schadenverh�tung GmBH (Germany)
VKF – Vereinigung Kantonaler Feuerversicherungen (Switzerland)
VNIIPO – Russia Fire Protection Science & Research Institute (Russia)
Zagrebinspekt (Croatia)

## Potable Water

�NTSZ – �llami N�peg�szs�g�gyi �s Tisztiorvosi Szolog�lat (Hungary)
ARPA – Agenzia Regionale per la Protezione dell'Ambiente (Italy)
DVGW – Deutscher Verein des Gas- und Wasserfaches e.V. (Germany)
Eurofins – ACS : Attestation de Conformit� Sanitaire (France)
HZJZ – Croatian National Institute of Public Health (Croatia)
NSF – NSF International (USA)
�VGW – �sterreichische Vereinigung f�r das Gas- und Wasserfach (Austria)
PZH – Panstwowy Zaklad Higieny (Poland)
RUVZPP – Region�lny �rad verejn�ho zdravotnictva so siddlom v Poprade (Slovakia)
SAI – SAI Global (Australia)
SPAN – Suruhanjaya Perkhidmatan Air Negara (Malaysia)
SVGW – Schweizerischer Verein des Gas- und Wasserfaches (Sweden)
UL – Underwriter's Laboratories, LLC (USA)
WRAS – Water Regulations Advisory Scheme (UK)
ZUOVA – ZDRAVOTN� �STAV se siddem v Ostrave (Czech Republic)

## Maritime

ABS – American Bureau of Shipping (USA)
BV – Bureau Veritas (France)
CCG – Canadian Coast Guard (Canada)
CSS – China Classification Society (China)
DNV – Det Norske Veritas (Norway)
GL – Germanischer Lloyd (Germany)
KRS – Korean Registry of Shipping (Korea)
LR– Lloyd's Register of Shipping (UK)
RINA – Registro Italiano Navale (Italy)
USCG – US Coast Guard (USA)

## HVAC

CSTB - Centre Scientifique et Technique du B�timent (France)
ITB – Instytut Techniki Budowlanej (Poland)
Sercons Europe BV (Russia)

**Plumbing**

IAPMO – International Association of Plumbing & Mechanical Officials (USA)
ICC-ES – International Code Council- Evaluation Service (USA)
NSF – NSF International (USA)

## COMPLIANCE:

## Codes/Standards

ANSI – American National Standards Institute (USA)
API – American Petroleum Institute (USA)
APSAD – Assembl�e Pleni�re Soci�t� Assurance Dommage (France)
AS/NZS – Standards Australia and Standards New Zealand (AU & NZ)
ASTM – American Society for Testing and Materials (USA)
AWWA – American Water Works Association (USA)
BOCA – Building Officials and Code Administrators (USA)
CSA – Canadian Standards Association (Canada)
CSFM – California State Fire Marshal (USA)
GOST R – Gosstandart (Russia)
IPC – International Plumbing Code (USA)
ISO – International Standards Organization (Global)
NACE – National Association of Corrosion Engineers (USA)
NFPA – National Fire Protection Association (USA)
SBCCI – Southern Building Code Congress International (USA)
UPC – Uniform Plumbing Code (USA)

## Pressure Equipment Safety

(97/23/EC) PED – Pressure Equipment Directive (Europe)
CSA B51 – "Boiler, Pressure Vessel, and Pressure Piping Code" (Canada)
CRN – Canadian Registration Number per CSA B51 (Canada)
(EU/305/2011) CPR – Construction Products Regulation- Fire safety products (Europe)

## Chemical Safety / Recycling

(EC/1907/2006) REACH– Registration, Evaluation, Authorization, and Registration of Chemicals (Europe)
(2002/95/EC) RoHS – Restriction of Hazardous Substances Directive (Europe)
(2002/96/EC) WEEE – Waste Electrical and Electronic Equipment Directive (Europe)

## Building Services

NBC – National Building Code (Canada)
PSB – TUV SUD PSB Singapore (Singapore)

## Explosive Environments

(94/9/EC) ATEX – Equipment and protective systems for potentially explosive atmospheres (Europe)
--

## Seismic

OSHDP – Office of Statewide Health Planning and Development (USA)
---

## Tools and Machinery

(2006/42/EC) MD – Machinery Directive (Europe)
--

  Copyright 2014, Victaulic  Company. All rights reserved.

No part of this Victaulic  catalog may be reproduced, stored in a retrieval system, or transmitted, in any form or by any means, electronic, mechanical, photocopy, recording or otherwise, without the prior written permission of Victaulic  Company.

# GENERAL CATALOG

## VICTAULIC® LOCATIONS WORLDWIDE

### NORTH & SOUTH AMERICA

#### US & WORLD HEADQUARTERS

P.O. Box 31  
Easton, PA 18044-0031 USA  
4901 Kesslersville Road  
Easton, PA 18040 USA  
1 800 PICK VIC  
1 800 742 5842  
(within North America)  
1 610 559 3300  
1 610 250 8817 (fax)  
pickvic@victaulic.com

#### CANADA

123 Newkirk Road  
Richmond Hill, ON L4C 3G5  
905 884 7444  
905 884 9774 (fax)  
viccanada@victaulic.com

### LATIN AMERICA

#### MEXICO

Calle Circuito del Marques  
No 8 al 11  
Parque Industrial El Marques  
Municipio El Marques  
Queretaro, Mexico  
CP 76246  
52 442 253 0066  
vical@victaulic.com

#### BRAZIL

Av. Marquês de São Vicente  
446 Cj 1303  
Várzea da Barra Funda –  
São Paulo-SP  
CEP 01139-000 – Brazil  
55 11 3548-4280  
vical@victaulic.com

### EUROPE, AFRICA, MIDDLE EAST & INDIA

#### UNITED KINGDOM

Units B1 & B2, SG1 Industrial Park  
Cockerell Close,  
Gunnels Wood Road  
Stevenage, Hertfordshire,  
SG 1 2NB (UK)  
44 0 1438 310 690  
44 0 1438 310 699 (fax)  
viceuro@victaulic.be

#### EUROPE & AFRICA

Prijkelstraat 36  
9810 Nazareth, Belgium  
32 9 381 15 00  
32 9 380 44 38 (fax)  
viceuro@victaulic.be

#### MIDDLE EAST

P.O. Box 17683  
Unit XB 8  
Jebel Ali Free Zone  
Dubai, United Arab Emirates  
971 4 883 88 70  
971 4 883 88 60 (fax)

#### INDIA

Victaulic Piping Products,  
India Priv. Ltd.  
Indialand Global Industrial Park  
Plot 4, Hinjewadi, Phase I, Mulshi  
Pune 411057 (India)  
91 20 67 919 300  
91 20 67 919 361 (fax)

### ASIA, AUSTRALIA & NEW ZEALAND

#### ASIA

Unit 06-10, Floor 3A  
A Mansion  
291 Fumin Road Shanghai,  
China 200031  
86 21 6170 1222  
86 21 6170 1221 (fax)  
vicap@victaulic.com

#### AUSTRALIA & NEW ZEALAND

7 Chambers Road  
Unit 1  
Altona North, Victoria  
Australia 3025  
1 300 PIC VIC  
1 300 742 842  
(within Australia)  
0-508-PICK-VIC  
0-508-7425-842  
(within New Zealand)  
61 3 9392 4000  
61 3 9392 4096 (fax)  
vicaust@victaulic.com

victaulic.com

