

W&O

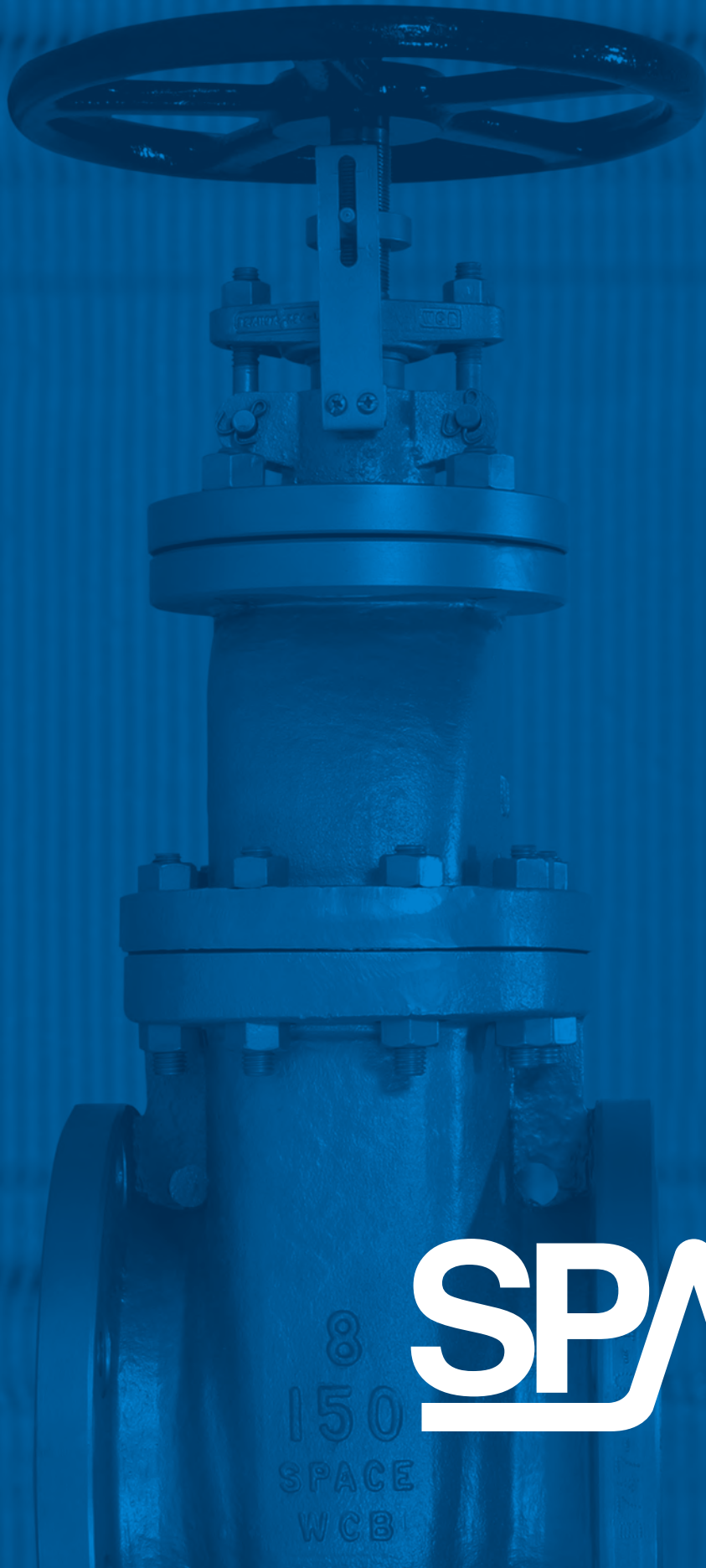

SPACE



www.wosupply.com | 800.962.9696

Table of Contents

Product Warranty	2
SPACE Figure Numbers	3
Gate Valves	4-8
Globe Valves	9-11
Angle Valves	12-14
Stop Check Globe	15
Swing Check Valves	16-18
Lift, Angle & Tilt Disc Check	19
Bellow Seal Gate	20
Double Disc Gate	21
Spectacle Type	22
Special Options	23
Engineering Data	24-27

The Space Valve brand is the recognized leader in the marine valve industry. We've earned this reputation since 1968 through our commitment to provide customers with a high quality, reliable product designed specifically to stand up to the rigorous conditions of the marine industry.

SPACE valves are highly used throughout the world on barges, container ships, tankers, offshore rigs, ferries and fishing boats. The quality, workmanship and integrity of SPACE valves allow you to feel confident that our product will meet your valve needs.

SPACE has a proprietary design that prevents common problems of galling. In the common size non-rising stem valves; we've upgraded the stem packing with high quality packing that provides higher lubricity and better protection for the valve stem. W&O tests and certifies each valve. Once tested and inspected, the valves are documented, tagged and distributed to our branches located throughout the United States and Internationally.

SPACE valves are available from stock as OS&Y and NRS Gates, Swing Checks, Globes, Angles and Stop Checks in sizes 2" through 24". They can also be produced in sizes up to 54". The SPACE line is available in hard-to-get marine sizes such as 3 1/2 and 5 inch. SPACE cast steel valves are also available in marine bronze, CR-13, 316 stainless, Monel and full stellite trims. Our valve shop can also customize and modify SPACE cast steel valves with indicators, by-passes, reach rod systems, actuators and many other options.

SPACE valves are an ABS Approved Product. We can also furnish certification to Det Norske Veritas, Lloyds, and Germanischer Lloyds with in-house testing at our facility in Jacksonville, Florida.

SPACE valves have a proven track record of reliability and performance. This reputation, plus our commitment to provide an excellent product that meets the strict requirements of the marine industry, makes SPACE the logical choice for meeting your sea water, fresh water, steam or oil system requirements.

PRODUCT WARRANTY

W & O Supply, Inc. (W&O) warranties all **SPACE** Valve Products for a period of 12 months from the invoice date. Warranty provides for the repair or replacement of material, if deemed defective. This warranty applies to only **SPACE** valves sold directly by W&O to original purchaser, this warranty does not apply to resellers of used or rebuilt **SPACE** Valves.

W&O warrants against defects and/or workmanship each product sold by them under the following terms and conditions:

- The product is of **SPACE** Valve Product manufacture.
- Product was under normal use and service at all times. The product was not at any time misused, operated beyond design capabilities or used for any purpose other than that for which it was intended.
- There has been no modifications or changes in design or function after leaving W&O facility(ies).
- Warranty claim must be made within the one (1) year period from date of shipment from W&O to Purchaser.
- Claimant is original Purchaser and there has been no other owner(s).
- Purchaser assumes all risk in selection of the product. It is the responsibility of the Purchaser to have received knowledgeable advice when selecting product type, material construction, etc.
- Purchaser is obligated to notify W&O promptly of any claimed defect, and shall be responsible for the return to W&O of all claimed defective product or parts. W&O shall have the right to inspect the product to determine obligation, prior to any settlement of provisions herein.
- Providing that the foregoing Warranty conditions have been met, W&O's obligation shall be limited to either the repair of the product, f.o.b. W&O, Jacksonville, Florida or the replacement of any part(s) with proven defective workmanship or materials.
- W&O shall not be held responsible for any consequential loss or incidental damages, personal injury, damages for loss of use, lost profit, work, production or any other damages in connection with this Warranty.
- If the valve has failed due to conditions other than those identified in this warranty agreement, the cost to re-supply the new valve will then be billed to the account of original purchaser.

SPACE FIGURE NUMBERS

000000-0

RATING	VALVE TYPE	MATERIAL	TRIM	OPTIONS
050 - 50 LB	1 OS&Y GATE	1 CARBON STEEL	B ALUMINUM BRONZE	SC STOP CHECK
125 - 125 LB	2 NRS GATE	2 CAST IRON	C CR13/HF	IND OPEN SHUT INDICATOR
150 - 150 LB	3 GLOBE	3 DUCTILE IRON	SS 316 STAINLESS	GO GEAR OPERATED
300 - 300 LB	4 ANGLE	5 BRONZE	HF FULL STELLITE	MO MOTOR OPERATED
600 - 600 LB	5 SWING CHECK	7 STAINLESS 316	M MONEL	BW BUTTWELD ENDS
900 - 900 LB	6 LIFT CHECK	8 ALLOY 20	T TEFLON INSERTED	CO CLEAN OUT
1500 - 1500 LB	7 TILT DISC CHECK			QO QUICK OPEN
	8 ANGLE CHECK			LW LEVER & WEIGHT
	9 SPECTACLE LINE BLIND			LS LIMIT SWITCH
	0 RIGID LINE BLIND			HB HAMMERBLOW HANDWHEEL
				DD DOUBLE DISC

TRIM CHART

TYPE	SEAT	DISC	STEM
Aluminum Bronze	Aluminum Bronze	Aluminum Bronze	Aluminum Bronze
CR13/HF	HF	CR13	CR13
Monel	HF	Monel	Monel
Full HF	HF	HF	HF
316SS	HF	316SS	316SS
Teflon	HF	CR13/ Teflon Inserted	CR13



NRS GATE VALVE

150 LB

BRONZE TRIM

APPLICABLE STANDARDS

Steel Valves, ANSI B16.34-1977, Standard Class
 Face-to-face, End-to-end, ANSI B16.10
 End Flanges, ANSI B16.5
 Weld Ends, ANSI B16.25



FIGURE 15021B

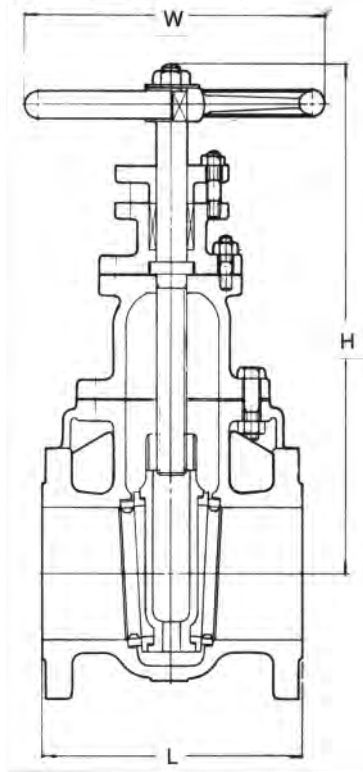

PART	MATERIALS	ASTM SPEC.
Body	Carbon steel	A216 Gr. WCB
Bonnet	Carbon steel	A216 Gr. WCB
Stuffing box	Carbon steel	A216 Gr. WCB
Wedge	Carbon steel	A216 Gr. WCB
Wedge facing	Aluminum Bronze	ASTM B150/C62400
Seat ring	Aluminum Bronze	ASTM B150/C62400
Stem	Aluminum Bronze	ASTM B505/C95400
Wedge nut	Ductile Iron	A439 TY D2
Back-seat bushing	Aluminum Bronze	ASTM B505/C95400
Gland	Carbon steel	ASTM A276-420
Gland flange	Carbon steel	A216 Gr. WCB
Gland eyebolt	Carbon steel	A193-B7
Gland eyebolt nut	Carbon steel	A194-2H
Bonnet stud bolt	Carbon steel	A193-B7
Bonnet stud bolt nut	Carbon steel	A194-2H
Bonnet gasket	Reinforced Graphite	Commercial
Stem packing	Graphite	Commercial
Handwheel	Ductile Iron	A395
Handwheel nut	Carbon steel	A194-2H

DIMENSIONS IN INCHES:

SIZE	2"	2-1/2"	3"	3-1/2"	4"	5"	6"	8"	10"	12"	14"	16"	18"	20"	24"
L Face to Face RF	7	7.5	8	8.5	9	10	10.5	11.5	13	14	15	16	17	18	20
H Height (Open)	12.9	15	15.5	17.6	18.6	22	23.2	27.6	31.35	34.5	37.6	43.75	47.3	54.4	64
W Handwheel Diam.	8	8	10	10	10	12	12	14	15.75	17.75	19.75	21.65	23.65	27	30
Weight (lbs)	49	68	87	108	119	199	243	354	534	778	1043	1310	1600	1950	2250



NRS GATE VALVE

150 LB

CR13/HF TRIM

APPLICABLE STANDARDS

Steel Valves, ANSI B16.34-1977, Standard Class
 Face-to-face, End-to-end, ANSI B16.10
 End Flanges, ANSI B16.5
 Weld Ends, ANSI B16.25

PART	MATERIALS	ASTM SPEC.
Body	Carbon steel	A216 Gr. WCB
Bonnet	Carbon steel	A216 Gr. WCB
Stuffing box	Carbon steel	A216 Gr. WCB
Wedge	Carbon steel	A216 Gr. WCB
Wedge facing	CR13	A216 TY 410
Seat ring	CR13	A105/HF Overlay
Stem	CR13	A276 TY410
Wedge nut	Ductile Iron	A439 TY D2
Back-seat bushing	CR13	A276 TY 410
Gland	CR13	A276 TY 410
Gland flange	Carbon steel	A216 Gr. WCB
Gland eyebolt	Carbon steel	A193-B7
Gland eyebolt nut	Carbon steel	A194-2H
Bonnet stud bolt	Carbon steel	A193-B7
Bonnet stud bolt nut	Carbon steel	A194-2H
Bonnet gasket	Reinforced Graphite	Commercial
*Stem packing	JC1065	Commercial
Handwheel	Ductile Iron	A395
Handwheel nut	Carbon steel	A194-2H

* All 15021C Valves provided with John Crane 1065 Stem Packing Rings



FIGURE 15021C

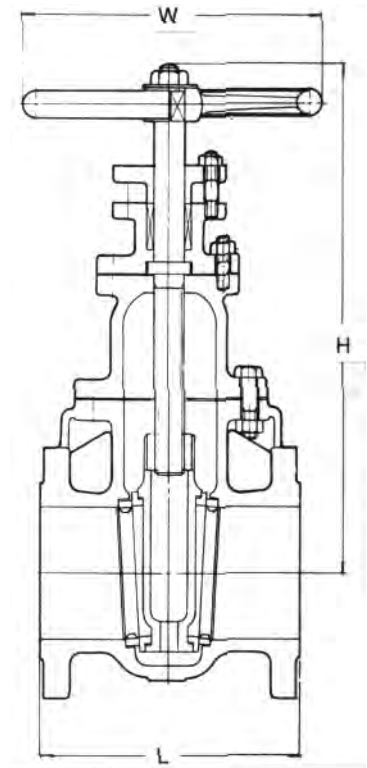

DIMENSIONS IN INCHES:

SIZE	2"	2-1/2"	3"	3-1/2"	4"	5"	6"	8"	10"	12"	14"	16"	18"	20"	24"
L Face to Face RF	7	7.5	8	8.5	9	10	10.5	11.5	13	14	15	16	17	18	20
H Height (Open)	12.9	15	15.5	17.6	18.6	22	23.2	27.6	31.35	34.5	37.6	43.75	47.3	54.4	64
W Handwheel Diam.	8	8	10	10	10	12	12	14	15.75	17.75	19.75	21.65	23.65	27	30
Weight (lbs)	49	68	87	108	119	199	243	354	534	778	1043	1310	1600	1950	2250



OS&Y GATE VALVE

150 LB

BRONZE TRIM

APPLICABLE STANDARDS

Steel Valves, ANSI B16.34-1977, Standard Class
 Face-to-face, End-to-end, ANSI B16.10
 End Flanges, ANSI B16.5
 Weld Ends, ANSI B16.25



FIGURE 15011B

PART	MATERIALS	ASTM SPEC.
Body	Carbon steel	A216 Gr. WCB
Bonnet	Carbon steel	A216 Gr. WCB
Yoke	Carbon steel	A216 Gr. WCB
Wedge	Carbon steel	A216 Gr. WCB
Wedge facing	Aluminum Bronze	ASTM B150/C62400
Seat ring	Aluminum Bronze	ASTM B150/C62400
Stem	Aluminum Bronze	ASTM B505/C95400
Yoke nut	Ductile Iron	A439 TY D2
Yoke nut retainer	Carbon steel	A216 Gr. WCB
Back-seat bushing	Aluminum Bronze	ASTM B505/C95400
Gland	Carbon steel	ASTM A276-420
Gland flange	Carbon steel	A105
Gland eyebolt	Steel	A193-B7
Gland eyebolt nut	Steel	A194-2H
Bonnet stud bolt	Steel	A193-B7
Bonnet stud bolt nut	Steel	A194-2H
Bonnet gasket	Reinforced Graphite	Commercial
Stem packing	Graphite	Commercial
Handwheel	Ductile Iron	A395
Handwheel nut	Carbon steel	A194-2H

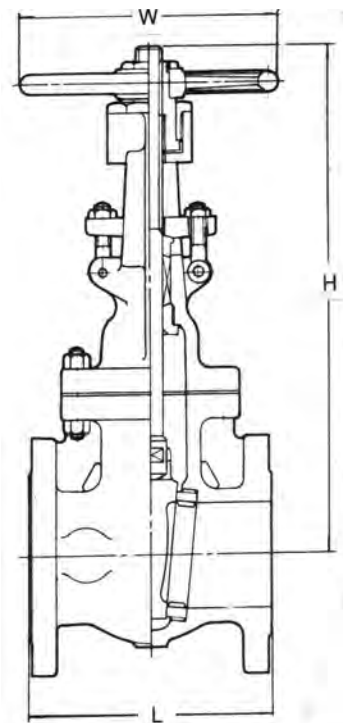

DIMENSIONS IN INCHES:

SIZE	2"	2-1/2"	3"	3-1/2"	4"	5"	6"	8"	10"	12"	14"	16"	18"	20"	24"
L Face to Face RF	7	7.5	8	8.5	9	10	10.5	11.5	13	14	15	16	17	18	20
H Height (Open)	15.37	17.25	19	21	23	25.5	30.12	37.65	45.25	53.25	59.4	67	74.5	83.5	98.5
H Height (Closed)	13	15	15.5	17.6	18.6	22	23.75	29	34.6	40.5	45.3	51	56.3	63.25	74
W Handwheel Diam.	8	8	10	10	10	12	12	14	15.75	18	19.75	21.65	23.62	26.75	30
Weight (lbs)	44	62	79	98	108	181	221	322	485	706	948	1191	1502	1940	3109



OS&Y GATE VALVE

150 LB

CR13/HF TRIM

APPLICABLE STANDARDS

Steel Gate Valves API 600
 Steel Valves, ANSI B16.34-1977, Standard Class
 Face-to-face, End-to-end, ANSI B16.10
 End Flanges, ANSI B16.5
 Weld Ends, ANSI B16.25



FIGURE 15011C

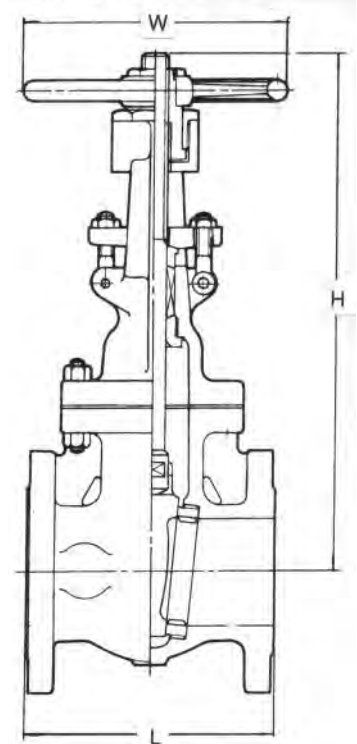

PART	MATERIALS	ASTM SPEC.
Body	Carbon steel	A216 Gr. WCB
Bonnet	Carbon steel	A216 Gr. WCB
Yoke	Carbon steel	A216 Gr. WCB
Wedge	Carbon steel	A216 Gr. WCB
Wedge facing	CR13	A276 TY 410
Seat ring	CR13	A105/HF Overlay
Stem	CR13	A276 TY 410
Yoke nut	Ductile Iron	A439 TY D2
Yoke nut retainer	Carbon steel	A216 Gr. WCB
Back-seat bushing	CR13	A276 TY 410
Gland	CR13	A276 TY 410
Gland flange	Carbon steel	ASTM A216-WCB
Gland eyebolt	Steel	A193-B7
Gland eyebolt nut	Steel	A194-2H
Bonnet stud bolt	Steel	A193-B7
Bonnet stud bolt nut	Steel	A194-2H
Bonnet gasket	Reinforced Graphite	Commercial
Stem packing	JC1065	Commercial
Handwheel	Ductile Iron	A395
Handwheel nut	Steel	A194-2H

* Wedge - 2-10" ASTM A217-CA15, CR13 Overlay
 * All 15011C Valves provided with John Crane 1065 Stem Packing Rings

DIMENSIONS IN INCHES:

SIZE	2"	2-1/2"	3"	3-1/2"	4"	5"	6"	8"	10"	12"	14"	16"	18"	20"	24"
L Face to Face RF	7	7.5	8	8.5	9	10	10.5	11.5	13	14	15	16	17	18	20
H Height (Open)	15.37	17.25	19	21	23	25.5	30.12	37.65	45.25	53.25	59.4	67	74.5	83.5	98.5
H Height (Closed)	13	15	15.5	17.6	18.6	22	23.75	29	34.6	40.5	45.3	51	26.3	63.25	74
W Handwheel Diam.	8	8	10	10	10	12	12	14	15.75	18	19.75	21.65	23.62	26.75	30
Weight (lbs)	44	62	79	98	108	181	221	322	485	706	948	1191	1502	1940	3109



OS&Y GATE VALVE

300-600-900-1500 LB

CR13/HF TRIM

APPLICABLE STANDARDS

- Steel Gate Valves API 600
- Steel Valves, ANSI B16.34-1977, Standard Class
- Face-to-face, End-to-end, ANSI B16.10
- End Flanges, ANSI B16.5
- Weld Ends, ANSI B16.25



FIGURE 30011C – 300 lb
 60011C – 600 lb
 90011C – 900 lb
 150011C – 1500 lb

300 LB DIMENSIONS IN INCHES:

SIZE	2"	2-1/2"	3"	3-1/2"	4"	5"	6"	8"	10"	12"	14"	16"	18"	20"	24"
L Face to Face RF	8.5	9.5	11.12	11.87	12	15	15.87	16.5	18	19.75	30	33	36	39	45
H Height (Open)	16.12	18	20	24	24	27.75	31.75	39.5	47.5	55.75	62.25	68	75.5	91	105
H Height (Closed)	13.75	15	16.5	19.5	19.5	22.2	25.2	30.75	37	43	48.25	52	58	70.5	80.25
W Handwheel Diam.	8	8	10	10	10	12	12	15.75	17.75	20	22	24	27	30	35.5
Weight (lbs)	65	78	110	149	172	231	335	541	794	1125	1720	2390	3100	4045	6150

600 LB DIMENSIONS IN INCHES:

SIZE	2"	2-1/2"	3"	3-1/2"	4"	5"	6"	8"	10"	12"	14"*	16"*	18"*	20"*	24"*
L Face to Face RF	11.5	13	14	15	17	20	22	26	31	33	35	39	43	47	55
H Height (Open)	16.5	18.75	20.5	25.5	25.5	30.25	33	40.25	48.5	57	61.75	70.75	75.5	87	101.5
H Height (Closed)	14	15.75	17	21	21	24.75	26.5	32	38	44.5	61.75	70.75	75.5	87	101.5
W Handwheel Diam.	8	10	10	12	12	16	18	20	24	27	24	24	24	24	24
Weight (lbs)	90	128	195	290	290	400	560	910	1370	1960	2740	3365	4330	5390	7965

*Sizes are provided with gear operator, as seen on page 23. Dimension is valve height from center of waterway bore including operator.

900 LB DIMENSIONS IN INCHES:

SIZE	2"	2-1/2"	3"	4"	6"	8"	10"*	12"*
L Face to Face RF	14.5	16.5	15	18	24	29	33	38
H Height (Open)	19.25	22.75	23	26.75	35.5	43.5	53	60
H Height (Closed)	13.75	15	16.6	19.5	25.2	30.75	53	60
W Handwheel Diam.	10	12	12	14	20	24	24	24
Weight (lbs)	165	290	222	380	740	1410	2420	3520

*Sizes are provided with gear operator, as seen on page 23. Dimension is valve height from center of waterway bore including operator.

1500 LB DIMENSIONS IN INCHES:

SIZE	2"	2-1/2"	3"	4"	6"	8"*	10"*	12"*
L Face to Face RF	14.5	16.5	18.5	21.5	27.75	32.75	39	44.5
H Height (Open)	19.25	22.75	23.75	27.5	38.75	45.75	54	64.5
H Height (Closed)	13.75	15	16.6	19.5	25.2	45.75	54	64.5
W Handwheel Diam.	10	12	14	16	20	24	24	24
Weight (lbs)	165	290	365	545	1285	2025	4200	6920

*Sizes are provided with gear operator, as seen on page 23. Dimension is valve height from center of waterway bore including operator.



GLOBE VALVE

150 LB

BRONZE TRIM

APPLICABLE STANDARDS

Steel Valves, ANSI B16.34-1977, Standard Class
 Face-to-face, End-to-end, ANSI B16.10
 End Flanges, ANSI B16.5
 Weld Ends, ANSI B16.25

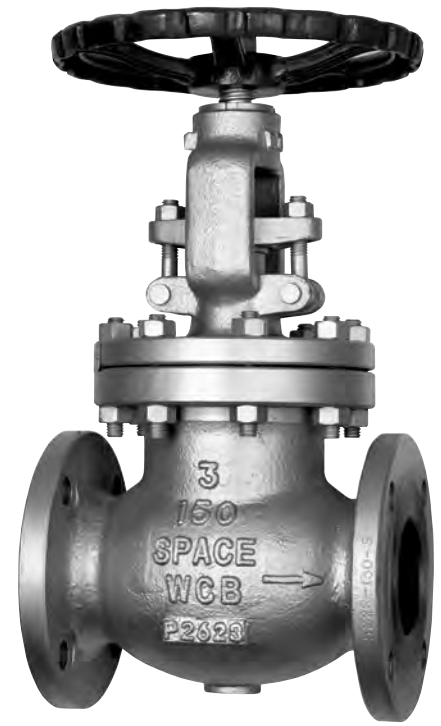
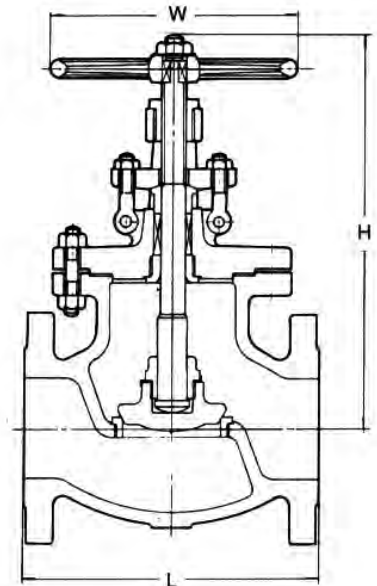

FIGURE 15031B



PART	MATERIALS	ASTM SPEC.
Body	Carbon steel	A216 Gr. WCB
Bonnet	Carbon steel	A216 Gr. WCB
Yoke	Carbon steel	A216 Gr. WCB
Disc	Carbon steel	ASTM A105/BRZ Overlay
Disc facing	Aluminum Bronze	ASTM B150/C62400
Disc nut	Aluminum Bronze	ASTM B505/C95400
Seat ring	Aluminum Bronze	ASTM B150/C62400
Stem	Aluminum Bronze	ASTM B505/C95400
Yoke nut	Ductile Iron	A439 TY D2
Back-seat bushing	Aluminum Bronze	ASTM B505/C95400
Gland	Carbon steel	ASTM A276-420
Gland flange	Carbon steel	A216 Gr. WCB
Gland bolt	Steel	A193-B7
Gland bolt nut	Steel	A194-2H
Bonnet stud bolt	Steel	A193-B7
Bonnet stud bolt nut	Steel	A194-2H
Bonnet gasket	Spiral Wound Graphite	Commercial
Stem packing	Graphite	Commercial
Handwheel	Ductile Iron	A395
Handwheel nut	Carbon steel	ASTM A194-2H

DIMENSIONS IN INCHES:

SIZE	2"	2-1/2"	3"	3-1/2"	4"	5"	6"	8"	10"	12"	14"	16"
L Face to Face RF	8	8.5	9.5	10.5	11.5	14	16	19.5	24.5	27.5	31	34
H Height (Open)	13.37	14.75	15.75	16.5	18.5	19.5	20.5	23.25	29.1	33.9	37.3	39.2
H Height (Closed)	12.5	13.75	14.5	15	17	18	18.75	20.75	26.1	30.4	33.0	34.2
W Handwheel Diam.	8	10	10	10	11.75	13.75	13.75	15.75	19.75	22	23.75	25.5
Weight (lbs)	51	64	90	115	141	197	254	373	631	893	1000	1400



GLOBE VALVE

150 LB

CR13/HF TRIM

APPLICABLE STANDARDS

Steel Valves, ANSI B16.34-1977, Standard Class
 Face-to-face, End-to-end, ANSI B16.10
 End Flanges, ANSI B16.5
 Weld Ends, ANSI B16.25

PART	MATERIALS	ASTM SPEC.
Body	Carbon steel	A216 Gr. WCB
Bonnet	Carbon steel	A216 Gr. WCB
Yoke	Carbon steel	A216 Gr. WCB
Disc	CR13	A276 TY 410
Disc nut	CR13	A276 TY 410
Seat ring	CR13	A105/HF Overlay
Stem	CR13	A276 TY 410
Yoke nut	Ductile Iron	A439 D2
Back-seat bushing	CR13	A276 TY 420
Gland	CR13	A276 TY 420
Gland flange	Carbon steel	A216 Gr. WCB
Gland bolt	Steel	A193-B7
Gland bolt nut	Steel	A194-2H
Bonnet stud bolt	Steel	A193-B7
Bonnet stud bolt nut	Steel	A194-2H
Bonnet gasket	Spiral Wound Graphite	Commercial
Stem packing	Graphite	Commercial
Handwheel	Ductile Iron	A395
Handwheel nut	Carbon steel	ASTM A194-2H

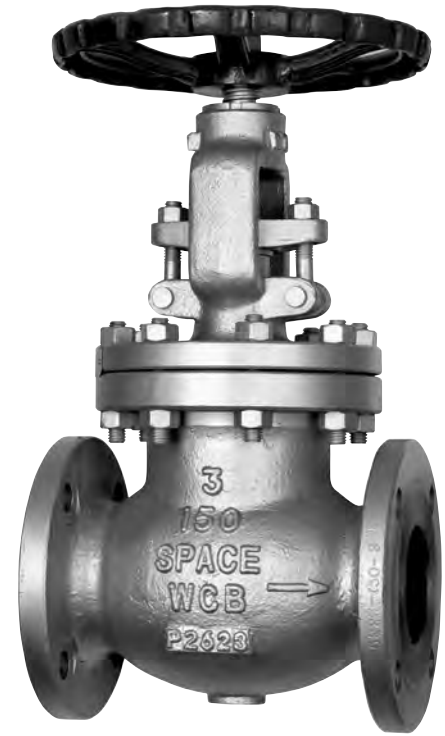
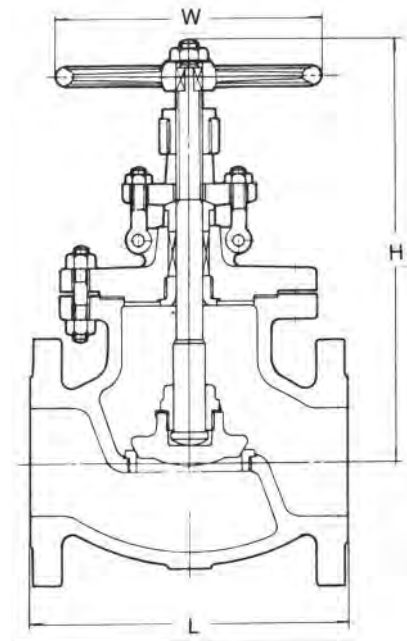

FIGURE 15031C



DIMENSIONS IN INCHES:

SIZE	2"	2-1/2"	3"	3-1/2"	4"	5"	6"	8"	10"	12"	14"	16"
L Face to Face RF	8	8.5	9.5	10.5	11.5	14	16	19.5	24.5	27.5	31	34
H Height (Open)	13.37	14.75	15.75	16.5	18.5	19.5	20.5	23.25	29.1	33.9	37.3	39.2
H Height (Closed)	12.5	13.75	14.5	15	17	18	18.75	20.75	26.1	30.4	33.0	34.2
W Handwheel Diam.	8	10	10	10	11.75	13.75	13.75	15.75	19.75	22	23.75	25.5
Weight (lbs)	51	64	90	115	141	197	254	373	631	893	1000	1400



GLOBE VALVE

300-600-900-1500 LB

CR13/HF TRIM

APPLICABLE STANDARDS

Steel Gate Valves API 600
 Steel Valves, ANSI B16.34-1977, Standard Class
 Face-to-face, End-to-end, ANSI B16.10
 End Flanges, ANSI B16.5
 Weld Ends, ANSI B16.25

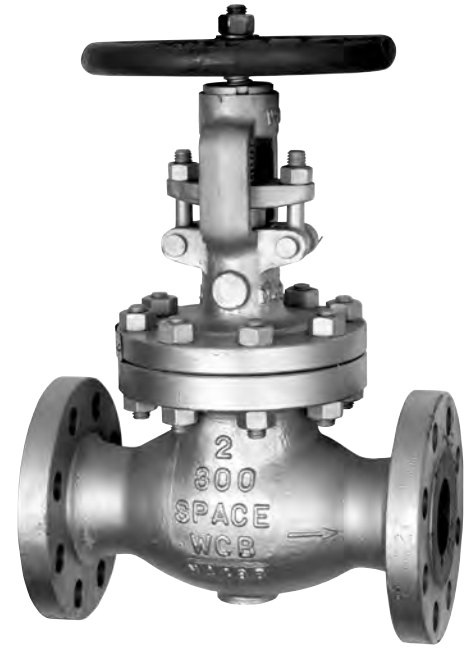

FIGURE 30031C – 300 lb
 60031C – 600 lb
 90031C – 900 lb
 150031C – 1500 lb

300 LB DIMENSIONS IN INCHES:

SIZE	2"	2-1/2"	3"	4"	5"	6"	8"	10"	12"	14"	16"
L Face to Face RF	10.5	11.5	12.5	14	15.75	17.5	22	24.5	28	33	34
H Height (Open)	14	15.37	16.5	19.5	22.75	26.5	36	37.37	40.75	50	57.75
H Height (Closed)	13	14.25	15.5	18	21	24.5	33.25	34.37	37.12	45.62	53
W Handwheel Diam.	8	10	10	13.75	17.75	19.75	22	23.75	25.5	27.5	31.5
Weight (lbs)	82	110	136	220	284	390	741	1015	1496	2240	3050

600 LB DIMENSIONS IN INCHES:

SIZE	2"	2-1/2"	3"	4"	5"	6"	8"	10"	12"	14"	16"
L Face to Face RF	11.5	13	14	17	20	22	26	31	33	35	39
H Height (Open)	15.75	19.75	19.5	23.5	27.5	31	40	46.5	51.25	57.75	60.75
H Height (Closed)	14.75	18.75	18.5	22.25	25.75	29.25	37.25	43.5	47.75	57.75	60.75
W Handwheel Diam.	10	12	14	18	20	22	23.75	27.5	31.5	32	39.5
Weight (lbs)	80	110	172	264	412	625	847	1295	1685	2325	3120

*Sizes are provided with gear operator, as seen on page 23. Dimension is valve height from center of waterway bore including operator.

900 LB DIMENSIONS IN INCHES:

SIZE	2"	3"	4"	6"	8"	10"
L Face to Face RF	14.5	15	18	24	29	33
H Height (Open)	19.75	21.5	27	38.75	47	63.25
H Height (Closed)	18.75	20.5	25.5	36.75	44.5	60
W Handwheel Diam.	14	18	19.75	23.75	27.5	31.5
Weight (lbs)	190	255	480	1150	1820	3100

1500 LB DIMENSIONS IN INCHES:

SIZE	2"	3"	4"	6"	8"	10"
L Face to Face RF	14.5	18.5	21.5	27.75	32.75	39.375
H Height (Open)	19.75	25.25	31.125	50.25	63	75.25
H Height (Closed)	18.75	24	29.75	50.25	63	75.25
W Handwheel Diam.	14	19.75	22	24	24	39.375
Weight (lbs)	210	410	670	1740	2080	3480

*Sizes are provided with gear operator, as seen on page 23. Dimension is valve height from center of waterway bore including operator.



ANGLE VALVE

150 LB

BRONZE TRIM

APPLICABLE STANDARDS

Steel Valves, ANSI B16.34-1977, Standard Class
 Face-to-face, End-to-end, ANSI B16.10
 End Flanges, ANSI B16.5
 Weld Ends, ANSI B16.25



FIGURE 15041B

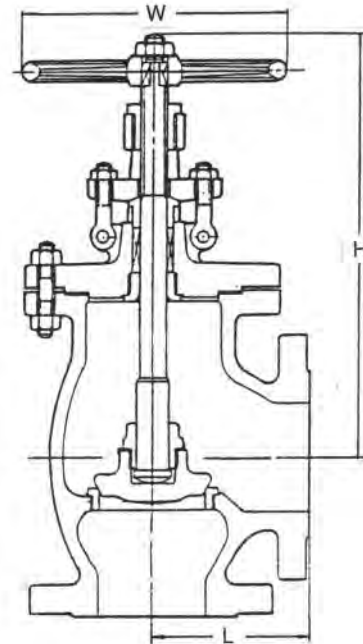

PART	MATERIALS	ASTM SPEC.
Body	Carbon steel	A216 Gr. WCB
Bonnet	Carbon steel	A216 Gr. WCB
Yoke	Carbon steel	A216 Gr. WCB
Disc	Carbon steel	ASTM A105/Bronze Overlay
Disc facing	Aluminum Bronze	ASTM B150/C62400
Disc nut	Aluminum Bronze	ASTM B505/C95400
Seat ring	Aluminum Bronze	ASTM B150/C62400
Stem	Aluminum Bronze	ASTM B505/C95400
Yoke nut	Ductile Iron	A439 D2
Back-seat bushing	Aluminum Bronze	ASTM B505/C95400
Gland	Carbon steel	ASTM A276-420
Gland flange	Carbon steel	A216 Gr. WCB
Gland bolt	Steel	A193-B7
Gland bolt nut	Steel	A194-2H
Bonnet stud bolt	Steel	A193-B7
Bonnet stud bolt nut	Steel	A194-2H
Bonnet gasket	Spiral Wound Graphite	Commercial
Stem packing	Graphite	Commercial
Handwheel	Ductile Iron	A395
Handwheel nut	Carbon steel	ASTM A194-2H

DIMENSIONS IN INCHES:

SIZE	2"	2-1/2"	3"	3-1/2"	4"	5"	6"	8"	10"	12"	14"	16"
L Face to Face RF	4	4.25	4.75	5.25	5.75	7	8	9.75	12.25	13.75	15.5	18
H Height (Open)	13.25	14.75	15.5	16.5	18.5	19.5	20.75	23.25	29.05	33.94	37.5	39.2
W Handwheel Diam.	8	10	10	10	11.75	13.75	13.75	15.75	19.75	22	23.75	25.5
Weight (lbs)	51	64	90	111	141	197	254	373	631	893	1100	1400



ANGLE VALVE

150 LB

CR13/HF TRIM

APPLICABLE STANDARDS

Steel Valves, ANSI B16.34-1977, Standard Class
 Face-to-face, End-to-end, ANSI B16.10
 End Flanges, ANSI B16.5
 Weld Ends, ANSI B16.25



FIGURE 15041C

PART	MATERIALS	ASTM SPEC.
Body	Carbon steel	A216 Gr. WCB
Bonnet	Carbon steel	A216 Gr. WCB
Yoke	Carbon steel	A216 Gr. WCB
Disc	CR13	A276 TY 410
Disc nut	CR13	A276 TY 410
Seat ring	CR13	A105/HF Overlay
Stem	CR13	A276 TY 410
Yoke nut	Ductile Iron	A439 D2
Back-seat bushing	CR13	A276 TY 420
Gland	CR13	A276 TY 420
Gland flange	Carbon steel	A216 Gr. WCB
Gland bolt	Steel	A193-B7
Gland bolt nut	Steel	A194-2H
Bonnet stud bolt	Steel	A193-B7
Bonnet stud bolt nut	Steel	A194-2H
Bonnet gasket	Spiral Wound Graphite	Commercial
Stem packing	Graphite	Commercial
Handwheel	Ductile Iron	A395
Handwheel nut	Carbon steel	ASTM A194-2H

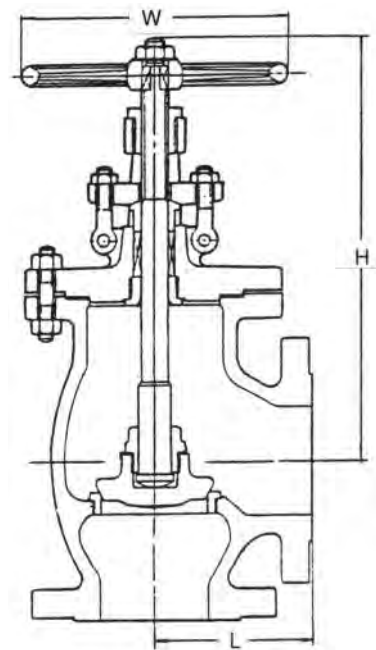

DIMENSIONS IN INCHES:

SIZE	2"	2-1/2"	3"	3-1/2"	4"	5"	6"	8"	10"	12"	14"	16"
L Face to Face RF	4	4.25	4.75	5.25	5.75	7	8	9.75	12.25	13.75	15.5	18
H Height (Open)	13.25	14.75	15.5	16.5	18.5	19.5	20.75	23.25	29.05	33.94	37.5	39.2
W Handwheel Diam.	8	10	10	10	11.75	13.75	13.75	15.75	19.75	22	23.75	25.5
Weight (lbs)	51	64	90	111	141	197	254	373	631	893	1100	1400



ANGLE VALVE

300-600-900-1500 LB

CR13/HF TRIM

APPLICABLE STANDARDS

Steel Gate Valves API 600

Steel Valves, ANSI B16.34-1977, Standard Class

Face-to-face, End-to-end, ANSI B16.10

End Flanges, ANSI B16.5

Weld Ends, ANSI B16.25



FIGURE 30041C – 300 lb
60041C – 600 lb
90041C – 900 lb
150041C – 1500 lb

300 LB DIMENSIONS IN INCHES:

SIZE	2"	2-1/2"	3"	4"	5"	6"	8"	10"	12"	14"	16"
L Face to Face RF	5.25	5.75	6.25	7	7.87	8.75	11	12.25	14	16.5	17
H Height (Open)	17	19.5	20.5	25.5	27	31	32.5	35	44.5	53	62
W Handwheel Diam.	8	10	10	14	14	20	20	24	27	30	30
Weight (lbs)	82	110	136	220	284	390	741	1015	1682	2240	3100

600 LB DIMENSIONS IN INCHES:

SIZE	2"	2-1/2"	3"	4"	5"	6"	8"	10"	12"	14"	16"
L Face to Face RF	5.75	6.5	7	8.5	10	11	13	15.5	16.5	17.5	19.5
H Height (Open)	20	22	25.5	29.5	35	41	55	57	59	61.5	64
W Handwheel Diam.	10	10	12	16	20	24	24	30	30	36	36
Weight (lbs)	92	144	176	315	492	705	1310	1900	2450	3100	3900

900 LB DIMENSIONS IN INCHES:

SIZE	3"	4"	5"	6"	8"	10"
L Face to Face RF	7.5	9	11	12	14.5	16.5
H Height (Open)	30	31	35	48	55	64
W Handwheel Diam.	16	20	20	24	30	30
Weight (lbs)	255	480	785	1150	1820	3100

1500 LB DIMENSIONS IN INCHES:

SIZE	2"	2-1/2"	3"	4"	5"	6"	8"
L Face to Face RF	7.25	8.25	9.25	10.75	13.25	13.87	19.5
H Height (Open)	27.5	28.5	30	38	45	53.5	64
W Handwheel Diam.	14	16	20	24	28	30	36
Weight (lbs)	210	315	410	670	1010	1240	2100

STOP CHECK GLOBE

150-300-600-900-1500 LB

AVAILABLE TRIMS:

- Aluminum Bronze
- CR13/HF
- Full Stellite
- 316 Stainless
- Monel

Dimensions same as Globe Valves listed on pages 9, 10, 11

STOP CHECK ANGLE

150-300-600-900-1500 LB

AVAILABLE TRIMS:

- Aluminum Bronze
- CR13/HF
- Full Stellite
- 316 Stainless
- Monel

Dimensions same as Angle Valves listed on pages 12, 13, 14

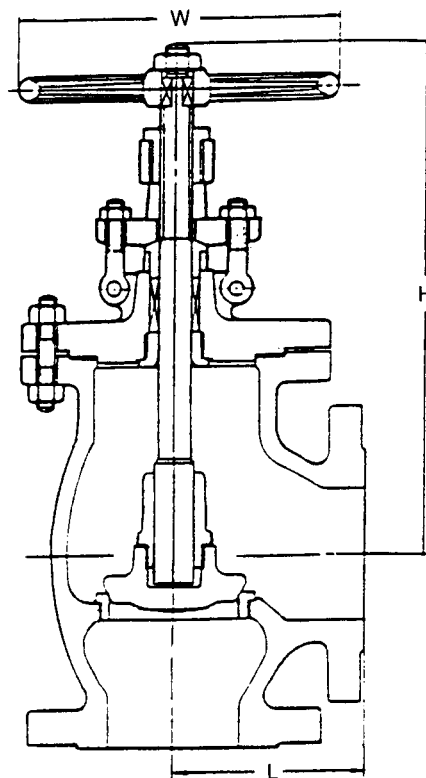
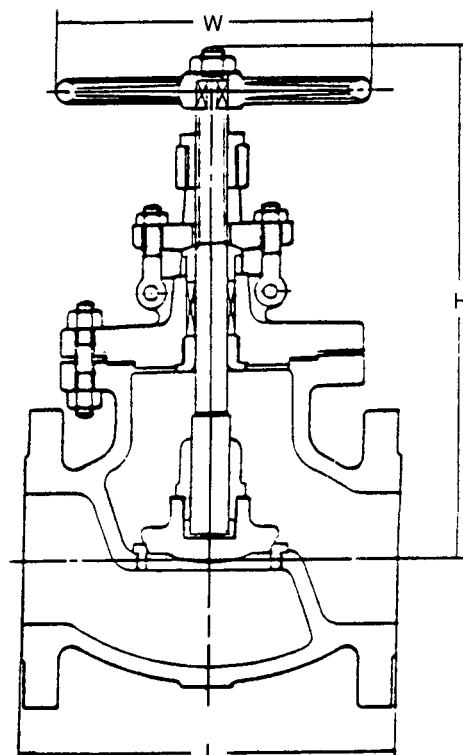

SPACE

SWING CHECK VALVE

150 LB

BRONZE TRIM

APPLICABLE STANDARDS

Steel Valves, ANSI B16.34-1977, Standard Class
 Face-to-face, End-to-end, ANSI B16.10
 End Flanges, ANSI B16.5
 Weld Ends, ANSI B16.25



FIGURE 15051B

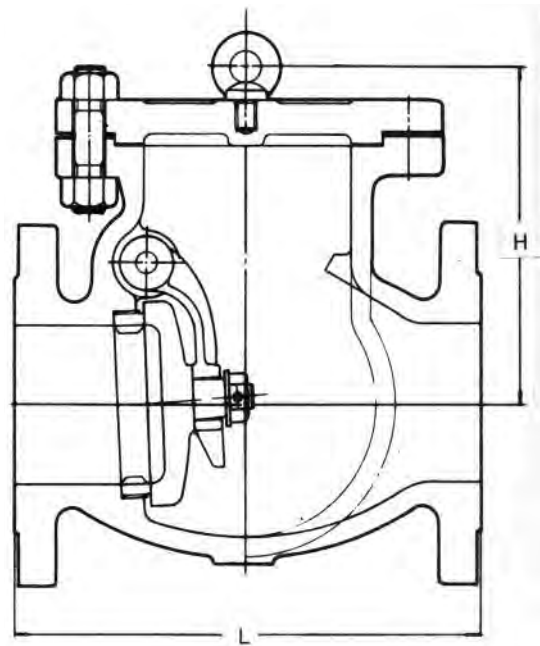

PART	MATERIALS	ASTM SPEC.
Body	Carbon steel	A216 Gr. WCB
Cap	Carbon steel	A216 Gr. WCB
Disc	Aluminum Bronze	ASTM B150/C62400
Disc nut	Aluminum Bronze	ASTM B505/C95400
Seat ring	Aluminum Bronze	ASTM B150/C62400
Hinge	Carbon steel	A216 Gr. WCB
Hinge pin	Aluminum Bronze	ASTM B505/C95400
Side plug	Carbon steel	ASTM A194-2H
Cap stud bolt	Carbon steel	A193-B7
Cap stud bolt nut	Carbon steel	A194-2H
Gasket	Reinforced Graphite	Commercial

DIMENSIONS IN INCHES:

SIZE	2"	2-1/2"	3"	3-1/2"	4"	5"	6"	8"	10"	12"	14"	16"	18"	20"	24"
L Face to Face RF	8	8.5	9.5	10.5	11.5	13	14	19.5	24.5	27.5	31	34	38.5	38.5	51
H Height	6	6.5	7.5	8.5	9	9.5	10.5	13	14	15	17.5	19	23	24	29
Weight (lbs)	41	53	72	92	98	138	174	305	460	620	860	990	1380	1710	2620

SPACE

SWING CHECK VALVE

150 LB

CR13/HF TRIM

APPLICABLE STANDARDS

Steel Valves, ANSI B16.34-1977, Standard Class

Face-to-face, End-to-end, ANSI B16.10

End Flanges, ANSI B16.5

Weld Ends, ANSI B16.25



FIGURE 15051C

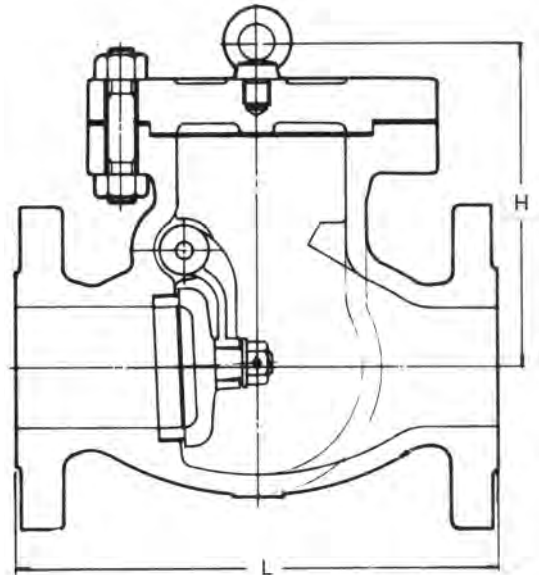

PART	MATERIALS	ASTM SPEC.
Body	Carbon steel	A216 Gr. WCB
Cap	Carbon steel	A216 Gr. WCB
Disc	CR13	ASTM A217-CA15
Disc nut	CR13	A276 TY 420
Seat ring	CR13	ASTM A105/HF Overlay
Hinge	Carbon steel	A216 Gr. WCB
Hinge pin	CR13	A276 TY 420
Side plug	CR13	A276 TY 420
Cap stud bolt	Carbon steel	A193-B7
Cap stud bolt nut	Carbon steel	A194-2H
Gasket	Reinforced Graphite	Commercial

DIMENSIONS IN INCHES:

SIZE	2"	2-1/2"	3"	3-1/2"	4"	5"	6"	8"	10"	12"	14"	16"	18"	20"	24"
L Face to Face RF	8	8.5	9.5	10.5	11.5	13	14	19.5	24.5	27.5	31	34	38.5	38.5	51
H Height	6	6.5	7.5	8.5	9	9.5	10.5	13	14	15	17.5	19	23	24	29
Weight (lbs)	41	53	72	92	98	138	174	305	460	620	860	990	1380	1710	2620



SWING CHECK VALVE

300-600-900-1500 LB

CR13/HF TRIM

APPLICABLE STANDARDS

- Steel Gate Valves API 600
- Steel Valves, ANSI B16.34-1977, Standard Class
- Face-to-face, End-to-end, ANSI B16.10
- End Flanges, ANSI B16.5
- Weld Ends, ANSI B16.25

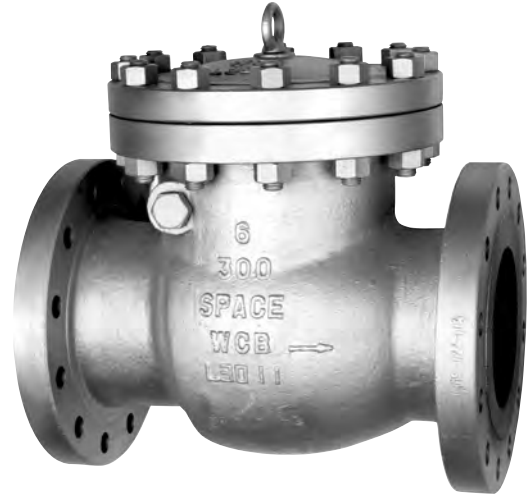

FIGURE 30051C – 300 lb
 60051C – 600 lb
 90051C – 900 lb
 150051C – 1500 lb

300 LB DIMENSIONS IN INCHES:

SIZE	2"	2-1/2"	3"	4"	5"	6"	8"	10"	12"	14"	16"	18"	20"	24"
L Face to Face RF	10.5	11.5	12.5	14	15.75	17.5	21	24.5	28	33	34	38.5	40	53
H Height	7	7.25	8.5	10.25	12	12.5	15	17.12	20.12	33	34	38.5	40	53
Weight (lbs)	35	55	70	115	140	200	390	470	635	900	1250	1555	1910	2715

600 LB DIMENSIONS IN INCHES:

SIZE	2"	2-1/2"	3"	4"	5"	6"	8"	10"	12"	14"	16"	18"	20"	24"
L Face to Face RF	11.5	13	14	17	20	22	26	31	33	35	39	43	47	55
H Height	7.25	7.5	9.12	10.37	14	14.75	16.75	20.37	22.5	23.75	24.5	29.75	29.37	37.75
Weight (lbs)	62	95	123	205	355	444	746	1146	1925	1947	2684	3564	4664	6510

900 LB DIMENSIONS IN INCHES:

SIZE	2"	2-1/2"	3"	4"	6"	8"	10"	12"	14"	16"	18"
L Face to Face RF	14.5	16.5	15	18	24	29	33	38	40.5	44.5	48
H Height	11.5	9.75	9.75	10.75	17.5	20.75	25	25.5	27.5	28.5	33.75
Weight (lbs)	154	220	200	330	506	851	1390	1982	2506	3548	4355

1500 LB DIMENSIONS IN INCHES:

SIZE	2"	2-1/2"	3"	4"	6"	8"	10"	12"	14"	16"
L Face to Face RF	14.5	16.5	18.5	21.5	27.75	32.75	39	44.5	49.5	54.5
H Height	11.5	13.25	13.25	16	20.5	24.12	30	32	34	38
Weight (lbs)	154	220	330	539	1210	2222	3410	5016	6732	9900

SPACE

LIFT CHECK

150-300-600-900-1500 LB

AVAILABLE TRIMS:

- Aluminum Bronze
- CR13/HF
- Full Stellite
- 316 Stainless
- Monel

Dimensions same as Swing Check Valves listed on pages 16, 17, 18

ANGLE CHECK

150-300-600-900-1500 LB

AVAILABLE TRIMS:

- Aluminum Bronze
- CR13/HF
- Full Stellite
- 316 Stainless
- Monel

Dimensions same as Angle Valves listed on pages 12, 13, 14

TILT DISC CHECK

150-300-600-900-1500 LB

AVAILABLE TRIMS:

- Aluminum Bronze
- CR13/HF
- Full Stellite
- 316 Stainless
- Monel

Dimensions same as Swing Check Valves listed on pages 16, 17, 18

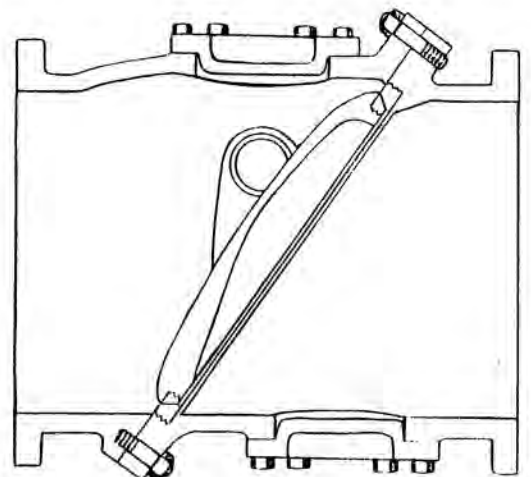
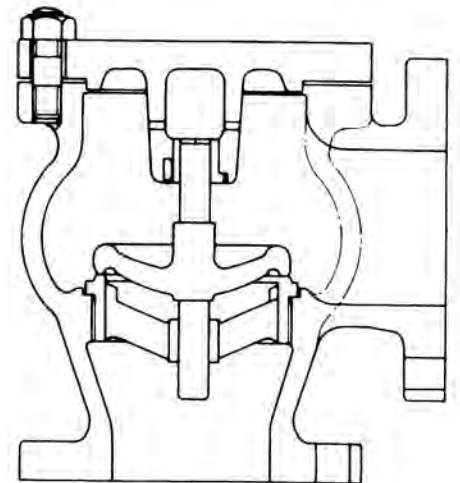
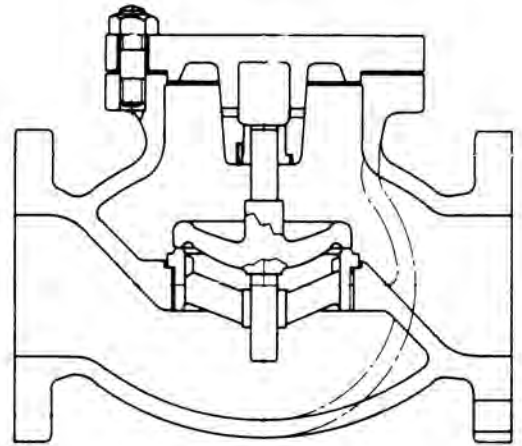



BELLOW SEAL GATE

150 LB

CR13/HF TRIM

BELLOW MATERIALS - SS316 or Inconel

APPLICABLE STANDARDS

Steel Valves, ANSI B16.34-1977, Standard Class

Face-to-face, End-to-end, ANSI B16.10

End Flanges, ANSI B16.5

Weld Ends, ANSI B16.25

PART	MATERIALS	ASTM SPEC.
Body	Cast steel	A216 Gr. WCB
Bonnet	Cast steel	A216 Gr. WCB
Yoke	Cast steel	A216 Gr. WCB
Wedge	Cast steel	A216 Gr. WCB
Wedge facing	CR13	A276 TY 410
Seat ring	CR13	A105/HF Overlay
Stem	CR13	A276 TY 410
Yoke nut	Ductile iron	A439 TY D2
Yoke nut Retainer	Carbon steel	A216 Gr. WCB
Gland	CR13	A276 TY 410
Gland flange	Cast steel	A216 Gr. WCB
Gland eyebolt	Steel	A193-B7
Gland eyebolt nut	Steel	A194-2H
Bonnet stud bolt	Steel	A193-B7
Bonnet stud bolt nut	Steel	A194-2H
Bonnet gasket	Reinforced graphite	Commercial
Stem packing	Graphite	Commercial
Bellows	Stainless steel or Inconel	Gr. 316 or Inconel
Handwheel	Ductile iron	A395
Handwheel nut	Steel	A194-2H



FIGURE 15011C-BS

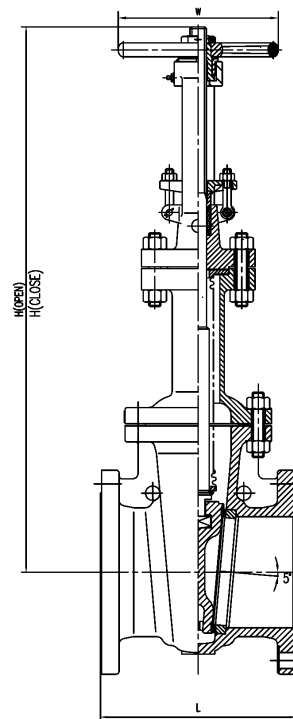

DIMENSIONS IN INCHES:

SIZE	2"	2-1/2"	3"	3-1/2"	4"	5"	6"	8"	10"	12"
L Face to Face RF	7	7.5	8	8.5	9	9.5	10.5	11.5	13	14
H Height (Open)	23.25	27.75	30.12	36	39	47.25	53.75	66.37	77.25	88.5
H Height (Closed)	21	24.75	26.75	31.5	34.37	41.75	47.25	57.75	66.5	75.75
W Handwheel Diam.	8	8	10	10	10	12	12	14	15.75	18
Weight (lbs)	52	75	95	115	128	215	260	385	560	805

SPACE

DOUBLE DISC GATE

50 LB WOG

- Ductile Iron, Cast Steel or Bronze Construction
- Bronze or Monel Trim
- Narrow Face to Face
- NRS or OS&Y
- Handwheel, Bevel Gear or Motor Operated
- ANSI or Navy Drilled

Also available with single tapered wedge.

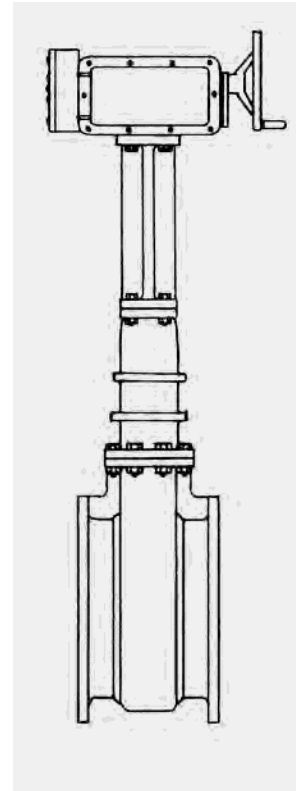

TYPICAL DIMENSIONS – OTHER FACE TO FACE DIMENSIONS ALSO AVAILABLE

SIZE	12"	14"	16"	18"	20"	22"	24"	26"	28"	30"	32"	36"	42"	48"	54"
Face to Face Equal to Chapman	11	11½	12	12½	13		13½			15		16	17½	19½	21
Face to Face Equal to Crane	10	10½	11	11½	12		13			14½		16	17½	19	
Face to Face Equal to Anchor				11	11	15	15	13	13½	14	15	18	15		

MANIFOLD VALVE CHEST

SUCTION & DISCHARGE TYPE

150 LB

- Cast Steel ASTM A216 Construction
- Aluminum Bronze Trim
- 2 to 6 Valves
- All valves have same bore size, but the suction and discharge connection may be chosen 1 or 2 sizes larger than valve bore
- Available in sizes 2" to 8"
- Fixed Disc Connection or Stop Check (SDNR)

*When placing an order or inquiry it is recommended to provide a drawing to indicate the location of the flange connections.

Other trim options are available upon request

SPECTACLE TYPE LINE BLIND

Cast Steel or Stainless
Flanged or Butt weld
Steel or Stainless Trim



DIMENSIONS IN INCHES:

SIZE	2"	2½"	3"	4"	5"	6"	8"	10"	12"	14"	16"	18"	20"	24"
Face to Face RF	7	7½	8	9	10	10½	11½	13	14	15	16	17	18	20
Face to Face BW	5	5½	5½	6	7	7	8	8	9	10	10	17	18	18½
Weight RF (lbs)	21	27	30	43	60	75	100	185	240	330	420	820	900	1600

RIGID TYPE LINE BLIND

Cast Steel
Flanged Ends 150 lb.
Steel or Stainless Trim

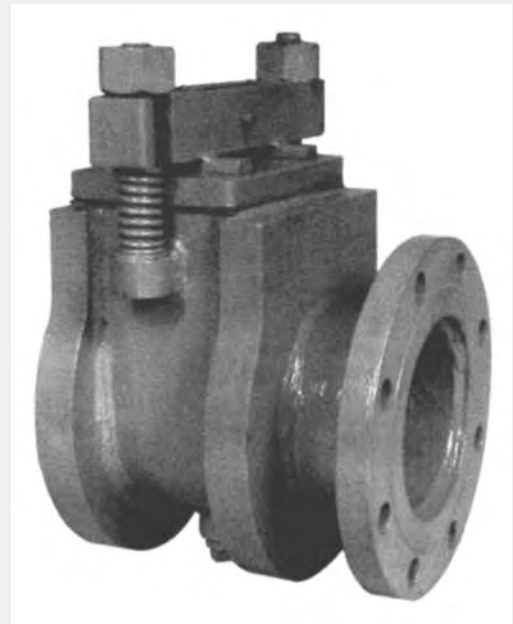

DIMENSIONS IN INCHES:

SIZE	2"	2½"	3"	4"	5"	6"	8"	10"	12"	14"	16"	18"	20"	24"
L Face to Face RF	7	7½	8	9	10	10½	11½	13	14	15	16	17	18	20
Weight RF (lbs)	44	49	65	75	95	110	145	195	250	615	830	930	1100	1300

SPECIAL OPTIONS



ANGLE GEAR
OPERATOR

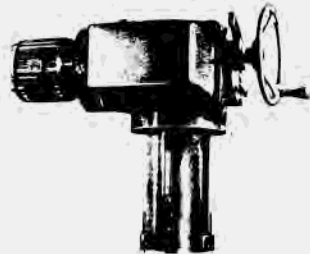

MOTOR OPERATOR
ELECTRIC, HYDRAULIC, PNEUMATIC



CYLINDER
OPERATOR

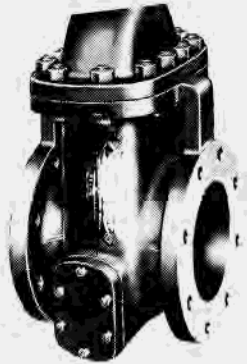

CLEANOUT

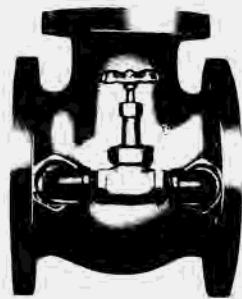

BYPASS & EQUALIZERS



OUTSIDE LEVER & WEIGHT



OPEN/SHUT INDICATOR



QUICK OPEN



HAMMERBLOW
HANDWHEEL



CHAIN SPROCKET
HANDWHEEL

MODIFICATIONS

- Special Trims
- Stem Extensions
- Metric Drillings
- Stop Checks & Non Returns
- V-Port Disc
- Special Face to Face Dimensions

TESTING

Performance tests are available to various licensing / testing authorities including:

- ABS-American Bureau of Shipping
- DNV-Det Norske Veritas
- Lloyds
- Germanischer Lloyds

ENGINEERING DATA

PRESSURE-TEMPERATURE RATINGS

CAST CARBON STEEL – ASTM A216 GR WCB

GATE, GLOBE, AND CHECK VALVES FLANGED AND BUTTWELDING ENDS

STANDARD CLASS PRESSURE-TEMPERATURE RATINGS ANSI B16.34 – 1977

TEMPERATURE IN °F	MAXIMUM ALLOWABLE NON-SHOCK WORKING PRESSURE IN psig BY CLASSES						
	150	300	400	600	900	1500	2500
-20 to 100	285	740	990	1480	2220	3705	6170
200	260	675	900	1350	2025	3375	5625
300	230	655	875	1315	1970	3280	5470
400	200	635	845	1270	1900	3170	5280
500	170	600	800	1200	1795	2995	4990
600	140	550	730	1095	1640	2735	4560
650	125	535	715	1075	1610	2685	4475
700	110	535	710	1065	1600	2665	4440
750	95	505	670	1010	1510	2520	4200
800	80	410	550	825	1235	2060	3430
850	65	270	355	535	805	1340	2230
900	50	170	230	345	515	860	1430
950	35	105	140	205	310	515	860
1000	20	50	70	105	155	260	430

CAST 1¼CR-½Mo STEEL – ASTM A217 GR WC6

GATE, GLOBE, AND CHECK VALVES FLANGED AND BUTTWELDING ENDS

STANDARD CLASS PRESSURE-TEMPERATURE RATINGS ANSI B16.34 – 1977

TEMPERATURE IN °F	MAXIMUM ALLOWABLE NON-SHOCK WORKING PRESSURE IN psig BY CLASSES						
	150	300	400	600	900	1500	2500
-20 to 100	290	750	1000	1500	2250	3750	6250
200	260	710	950	1425	2135	3560	5930
300	230	675	895	1345	2020	3365	5605
400	200	660	880	1315	1975	3290	5485
500	170	640	855	1285	1925	3210	5350
600	140	605	805	1210	1815	3025	5040
650	125	590	785	1175	1765	2940	4905
700	110	570	755	1135	1705	2840	4730
750	95	530	710	1065	1595	2660	4430
800	80	510	675	1015	1525	2540	4230
850	65	485	650	975	1460	2435	4060
900	50	450	600	900	1350	2245	3745
950	35	380	505	755	1130	1885	3145
1000	20	225	300	445	670	1115	1860
1050	20*	140	185	275	410	685	1145
1100	20*	95	130	190	290	480	800

*For Welding end valves only. Flanged end ratings terminate at 1000°F.

For pressure-temperature ratings of other materials, see ANSI B16.34

Product used under the jurisdiction of the ASME Boiler and Vessel Code or of the ANSI Code for Pressure Piping is subject to any limitation of that code, including any maximum temperature limitation for a material, or a code rule governing the use of a material at low temperature.

Where welded construction is used, consideration should be given to the possibility of graphite formation in carbon-molybdenum steel above 875F.

Allowable pressure may be interpolated between the temperatures.

The temperature shown on the corresponding pressure rating shall be the material temperature of the pressure retaining structure, assumed to be the temperature of the contained fluid. Use of a pressure rating at a material temperature other than that of the contained fluid is the responsibility of the user, and subject to the requirements of any applicable code.

The use of these pressure ratings requires that the gasket of a flanged joint conform to the requirements of ANSI B16.5. The user is responsible for selection of gasket dimensions and materials to withstand the required bolt loading without injurious crushing, and also the suitability for the service conditions.

ENGINEERING DATA

END DIMENSIONS

STEEL FLANGE DIMENSIONS AND DRILLING TEMPLATES

CLASS 150 AND 300 - ANSI B16.5

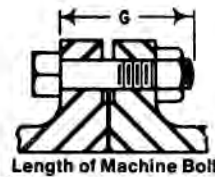
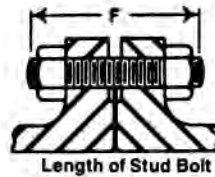
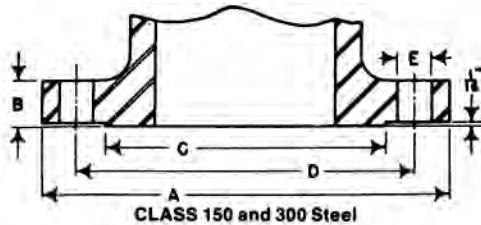

$\frac{1}{16}$ -Inch Raised Face Joint

Class 150 Steel Flanges

Dimensions in Inches

Nominal Pipe Size	Flange Diameter A	Flange Thickness Companion Flange B	Valve Flange B	Diameter of Raised Face C	Diameter of Bolt Circle D	Diameter of Bolt Holes E	Number of Bolts	Diameter of Bolts	Length of Stud Bolts with 2 Nuts F	Length of Machine Bolts G
1/2	3 1/2	7/16	—	1 3/8	2 3/8	5/8	4	1/2	2 1/4	1 3/4
3/4	3 7/8	1/2	—	1 11/16	2 3/4	5/8	4	1/2	2 1/4	2
1	4 1/4	9/16	7/16	2	3 1/8	5/8	4	1/2	2 1/2	2
1 1/4	4 5/8	5/8	1/2	2 1/2	3 1/2	5/8	4	1/2	2 1/2	2 1/4
1 1/2	5	11/16	9/16	2 7/8	3 3/8	5/8	4	1/2	2 3/4	2 1/4
2	6	3/4	5/8	3 5/8	4 3/4	3/4	4	5/8	3	2 3/4
2 1/2	7	7/8	11/16	4 1/8	5 1/2	3/4	4	5/8	3 1/4	3
3	7 1/2	15/16	3/4	5	6	3/4	4	5/8	3 1/2	3
3 1/2	8 1/2	15/16	13/16	5 1/2	7	3/4	8	5/8	3 1/2	3
4	9	15/16	13/16	6 3/16	7 1/2	3/4	8	5/8	3 1/2	3
5	10	15/16	13/16	7 5/16	8 1/2	7/8	8	3/4	3 3/4	3 1/4
6	11	1	13/16	8 1/2	9 1/2	7/8	8	3/4	3 3/4	3 1/4
8	13 1/2	1 1/8	13/16	10 5/8	11 3/4	7/8	8	3/4	4	3 1/2
10	16	1 3/16	13/16	12 3/4	14 1/4	1	12	7/8	4 1/2	3 3/4
12	19	1 1/4	13/16	15	17	1	12	7/8	4 1/2	4
14	21	1 3/8	13/16	16 1/4	18 3/4	1 1/8	12	1	5	4 1/4
16	23 1/2	1 7/16	13/16	18 1/2	21 1/4	1 1/8	16	1	5 1/4	4 1/2
18	25	1 9/16	13/16	21	22 3/4	1 1/4	16	1 1/8	5 3/4	4 3/4
20	27 1/2	1 11/16	13/16	23	25	1 1/4	20	1 1/8	6	5 1/4
24	32	1 7/8	13/16	27 1/4	29 1/2	1 3/8	20	1 1/2	6 3/4	5 3/4

Class 300 Steel Flanges

Dimensions in Inches

Nominal Pipe Size	Flange Diameter A	Flange Thickness B	Diameter of Raised Face C	Diameter of Bolt Circle D	Diameter of Bolt Holes E	Number of Bolts	Diameter of Bolts	Length of Stud Bolts with 2 Nuts F	Length of Machine Bolts G
1/2	3 3/4	9/16	1 3/8	2 5/8	5/8	4	1/2	2 1/2	2
3/4	4 5/8	5/8	1 11/16	3 1/4	3/4	4	5/8	2 3/4	2 1/2
1	4 7/8	11/16	2	3 1/2	3/4	4	5/8	3	2 1/2
1 1/4	5 1/4	3/4	2 1/2	3 7/8	3/4	4	5/8	3	2 3/4
1 1/2	6 1/8	13/16	2 7/8	4 1/2	7/8	4	3/4	3 1/2	3
2	6 1/2	7/8	3 5/8	5	3/4	8	5/8	3 1/4	3
2 1/2	7 1/2	1	4 1/8	5 7/8	7/8	8	3/4	3 3/4	3 1/4
3	8 1/4	1 1/8	5	6 5/8	7/8	8	3/4	4	3 1/2
3 1/2	9	1 3/16	5 1/2	7 1/4	7/8	8	3/4	4 1/4	3 3/4
4	10	1 1/4	6 3/16	7 7/8	7/8	8	3/4	4 1/4	3 3/4
5	11	1 3/8	7 5/16	9 1/4	7/8	8	3/4	4 1/2	4
6	12 1/2	1 7/16	8 1/2	10 5/8	7/8	12	3/4	4 3/4	4 1/4
8	15	1 5/8	10 5/8	13	1	12	7/8	5 1/4	4 3/4
10	17 1/2	1 7/8	12 3/4	15 1/4	1 1/8	16	1	6	5 1/4
12	20 1/2	2	15	17 3/4	1 1/4	16	1 1/8	6 1/2	5 3/4
14	23	2 1/8	16 1/4	20 1/4	1 1/4	20	1 1/8	6 3/4	6
16	25 1/2	2 1/4	18 1/2	22 1/2	1 3/8	20	1 1/4	7 1/4	6 1/2
18	28	2 3/8	21	24 3/4	1 3/8	24	1 1/4	7 1/2	6 3/4
20	30 1/2	2 1/2	23	27	1 3/8	24	1 1/4	8	7
24	36	2 3/4	27 1/4	32	1 5/8	24	1 1/2	9	7 3/4

The regular $\frac{1}{16}$ -inch raised face of Class 150 and 300 flanges is included in the minimum flange thickness given above, but other raised faces must be added thereto.

ENGINEERING DATA

END DIMENSIONS

STEEL FLANGE DIMENSIONS AND DRILLING TEMPLATES

CLASS 400 AND 600 - ANSI B16.5

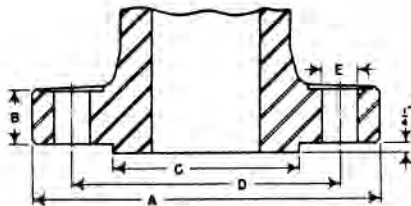

Class 400 and 600 Steel

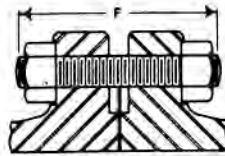

Male to Male
Flanged Joint

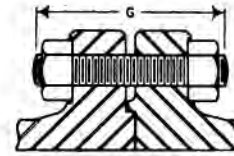

Male to Female
Flanged Joint

Stud bolt length "G" also applies for tongue to groove flanged joint.

Class 400 Steel Flanges Dimensions in Inches

Nominal Pipe Size	Flange Diameter A	Flange Thickness B	Diameter of Raised Face C	Diameter of Bolt Circle D	Diameter of Bolt Holes E	Number of Stud Bolts	Diameter of Stud Bolts	Length of Stud Bolts with 2 Nuts	
								F	G
4*	10	1 $\frac{3}{8}$	6 $\frac{3}{16}$	7 $\frac{7}{8}$	1	8	$\frac{7}{8}$	5 $\frac{1}{4}$	5
5	11	1 $\frac{1}{2}$	7 $\frac{9}{16}$	9 $\frac{1}{4}$	1	8	$\frac{7}{8}$	5 $\frac{1}{2}$	5 $\frac{1}{4}$
6	12 $\frac{1}{2}$	1 $\frac{5}{8}$	8 $\frac{1}{2}$	10 $\frac{5}{8}$	1	12	$\frac{7}{8}$	5 $\frac{3}{4}$	5 $\frac{1}{2}$
8	15	1 $\frac{7}{8}$	10 $\frac{5}{8}$	13	1 $\frac{1}{8}$	12	1	6 $\frac{1}{2}$	6 $\frac{1}{4}$
10	17 $\frac{1}{2}$	2 $\frac{1}{8}$	12 $\frac{3}{4}$	15 $\frac{1}{4}$	1 $\frac{1}{4}$	16	1 $\frac{1}{8}$	7 $\frac{1}{4}$	7
12	20 $\frac{1}{2}$	2 $\frac{1}{4}$	15	17 $\frac{3}{4}$	1 $\frac{3}{8}$	16	1 $\frac{1}{4}$	7 $\frac{3}{4}$	7 $\frac{1}{2}$
14	23	2 $\frac{3}{8}$	16 $\frac{1}{4}$	20 $\frac{1}{4}$	1 $\frac{3}{8}$	20	1 $\frac{1}{4}$	8	7 $\frac{3}{4}$
16	25 $\frac{1}{2}$	2 $\frac{1}{2}$	18 $\frac{1}{2}$	22 $\frac{1}{2}$	1 $\frac{1}{2}$	20	1 $\frac{3}{8}$	8 $\frac{1}{2}$	8 $\frac{1}{4}$
18	28	2 $\frac{5}{8}$	21	24 $\frac{3}{4}$	1 $\frac{1}{2}$	24	1 $\frac{3}{8}$	8 $\frac{3}{4}$	8 $\frac{1}{2}$
20	30 $\frac{1}{2}$	2 $\frac{3}{4}$	23	27	1 $\frac{5}{8}$	24	1 $\frac{1}{2}$	9 $\frac{1}{2}$	9 $\frac{1}{4}$
24	36	3	27 $\frac{1}{4}$	32	1 $\frac{7}{8}$	24	1 $\frac{3}{4}$	10 $\frac{1}{2}$	10 $\frac{1}{4}$

*Use Class 600 dimensions in sizes smaller than 4-inch.

Class 600 Steel Flanges Dimensions in Inches

Nominal Pipe Size	Flange Diameter A	Flange Thickness B	Diameter of Raised Face C	Diameter of Bolt Circle D	Diameter of Bolt Holes E	Number of Stud Bolts	Diameter of Stud Bolts	Length of Stud Bolts with 2 Nuts	
								F	G
$\frac{1}{2}$	3 $\frac{3}{4}$	$\frac{9}{16}$	1 $\frac{3}{8}$	2 $\frac{5}{8}$	$\frac{5}{8}$	4	$\frac{1}{2}$	3	2 $\frac{3}{4}$
$\frac{3}{4}$	4 $\frac{5}{8}$	$\frac{5}{8}$	1 $\frac{11}{16}$	3 $\frac{1}{4}$	$\frac{3}{4}$	4	$\frac{5}{8}$	3 $\frac{1}{4}$	3
1	4 $\frac{7}{8}$	1 $\frac{1}{16}$	2	3 $\frac{1}{2}$	$\frac{3}{4}$	4	$\frac{5}{8}$	3 $\frac{1}{2}$	3 $\frac{1}{4}$
1 $\frac{1}{4}$	5 $\frac{1}{4}$	1 $\frac{3}{16}$	2 $\frac{1}{2}$	3 $\frac{7}{8}$	$\frac{3}{4}$	4	$\frac{5}{8}$	3 $\frac{3}{4}$	3 $\frac{1}{2}$
1 $\frac{1}{2}$	6 $\frac{1}{8}$	$\frac{7}{8}$	2 $\frac{7}{8}$	4 $\frac{1}{2}$	$\frac{7}{8}$	4	$\frac{3}{4}$	4	3 $\frac{3}{4}$
2	6 $\frac{1}{2}$	1	3 $\frac{5}{8}$	5	$\frac{3}{4}$	8	$\frac{5}{8}$	4	3 $\frac{3}{4}$
2 $\frac{1}{2}$	7 $\frac{1}{2}$	1 $\frac{1}{8}$	4 $\frac{1}{8}$	5 $\frac{7}{8}$	$\frac{7}{8}$	8	$\frac{3}{4}$	4 $\frac{1}{2}$	4 $\frac{1}{4}$
3	8 $\frac{1}{4}$	1 $\frac{1}{4}$	5	6 $\frac{5}{8}$	$\frac{7}{8}$	8	$\frac{3}{4}$	4 $\frac{3}{4}$	4 $\frac{1}{2}$
3 $\frac{1}{2}$	9	1 $\frac{3}{8}$	5 $\frac{1}{2}$	7 $\frac{1}{4}$	1	8	$\frac{7}{8}$	5	5
4	10 $\frac{3}{4}$	1 $\frac{1}{2}$	6 $\frac{3}{16}$	8 $\frac{1}{2}$	1	8	$\frac{7}{8}$	5 $\frac{1}{2}$	5 $\frac{1}{4}$
5	13	1 $\frac{3}{4}$	7 $\frac{9}{16}$	10 $\frac{1}{2}$	1 $\frac{1}{8}$	8	1	6 $\frac{1}{4}$	6
6	14	1 $\frac{7}{8}$	8 $\frac{1}{2}$	11 $\frac{1}{2}$	1 $\frac{1}{8}$	12	1	6 $\frac{1}{2}$	6 $\frac{1}{4}$
8	16 $\frac{1}{2}$	2 $\frac{3}{16}$	10 $\frac{5}{8}$	13 $\frac{3}{4}$	1 $\frac{1}{4}$	12	1 $\frac{1}{8}$	7 $\frac{1}{2}$	7 $\frac{1}{4}$
10	20	2 $\frac{1}{2}$	12 $\frac{3}{4}$	17	1 $\frac{3}{8}$	16	1 $\frac{1}{4}$	8 $\frac{1}{4}$	8
12	22	2 $\frac{5}{8}$	15	19 $\frac{1}{4}$	1 $\frac{3}{8}$	20	1 $\frac{1}{4}$	8 $\frac{1}{2}$	8 $\frac{1}{4}$
14	23 $\frac{3}{4}$	2 $\frac{3}{4}$	16 $\frac{1}{4}$	20 $\frac{3}{4}$	1 $\frac{1}{2}$	20	1 $\frac{3}{8}$	9	8 $\frac{3}{4}$
16	27	3	18 $\frac{1}{2}$	23 $\frac{3}{4}$	1 $\frac{5}{8}$	20	1 $\frac{1}{2}$	9 $\frac{3}{4}$	9 $\frac{1}{2}$
18	29 $\frac{1}{4}$	3 $\frac{1}{4}$	21	25 $\frac{3}{4}$	1 $\frac{3}{4}$	20	1 $\frac{5}{8}$	10 $\frac{1}{2}$	10 $\frac{1}{4}$
20	32	3 $\frac{1}{2}$	23	28 $\frac{1}{2}$	1 $\frac{3}{4}$	24	1 $\frac{5}{8}$	11 $\frac{1}{4}$	11
24	37	4	27 $\frac{1}{4}$	33	2	24	1 $\frac{7}{8}$	12 $\frac{3}{4}$	12 $\frac{1}{2}$

The regular $\frac{1}{4}$ -inch raised face of Class 400 and 600 flanges is not included in the minimum flange thickness given above. The addition of any facing is beyond the outside edge of the flange.

ENGINEERING DATA

END DIMENSIONS

STEEL FLANGE DIMENSIONS AND DRILLING TEMPLATES

CLASS 900 AND 1500- ANSI B16.5

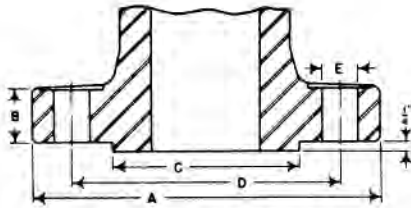

Class 900 and 1500 Steel

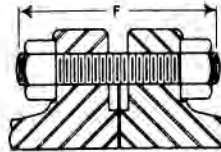

Male to Male
Flanged Joint

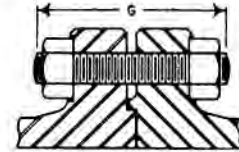

Male to Female
Flanged Joint

Stud Bolt length "G" also applies
for tongue to groove flanged joint.

Class 900 Steel Flanges Dimensions in Inches

Nominal Pipe Size	Flange Diameter A	Flange Thickness B	Diameter of Raised Face C	Diameter of Bolt Circle D	Diameter of Bolt Holes E	Number of Stud Bolts	Diameter of Stud Bolts	Length of Stud Bolts with 2 Nuts	
								F	G
3*	9½	1½	5	7½	1	8	7/8	5½	5¼
4	11½	1¾	6 ⁹ / ₁₆	9¼	1¼	8	1½	6½	6¼
5	13¾	2	7 ⁵ / ₁₆	11	1 ³ / ₈	8	1¼	7¼	7
6	15	2 ³ / ₁₆	8½	12½	1¼	12	1½	7½	7¼
8	18½	2½	10 ⁵ / ₈	15½	1½	12	1 ³ / ₈	8½	8¼
10	21½	2¾	12¾	18½	1½	16	1 ³ / ₈	9	8¾
12	24	3¼	15	21	1½	20	1 ³ / ₈	9¾	9½
14	25¼	3 ³ / ₈	16¼	22	1 ⁵ / ₈	20	1½	10½	10¼
16	27¾	3½	18½	24¼	1¾	20	1 ⁵ / ₈	11	10¾
18	31	4	21	27	2	20	1 ⁷ / ₈	12¾	12½
20	33¾	4¼	23	29½	2 ¹ / ₈	20	2	13½	13¼
24	41	5½	27¼	35½	2 ⁵ / ₈	20	2½	17	16¾

*Use Class 1500 dimensions in sizes smaller than 3-inch.

Class 1500 Dimensions in Inches

Nominal Pipe Size	Flange Diameter A	Flange Thickness B	Diameter of Raised Face C	Diameter of Bolt Circle D	Diameter of Bolt Holes E	Number of Stud Bolts	Diameter of Stud Bolts	Length of Stud Bolts with 2 Nuts	
								F	G
½	4¾	7/8	1 ³ / ₈	3¼	7/8	4	¾	4	3¾
¾	5½	1	1 ¹¹ / ₁₆	3½	7/8	4	¾	4¼	4
1	5 ⁷ / ₈	1 ¹ / ₈	2	4	1	4	7/8	4¾	4½
1¼	6¼	1 ¹ / ₈	2½	4 ³ / ₈	1	4	7/8	4¾	4½
1½	7	1¼	2 ⁷ / ₈	4 ⁷ / ₈	1 ¹ / ₈	4	1	5¼	5
2	8½	1½	3 ⁵ / ₈	6½	1	8	7/8	5½	5¼
2½	9 ⁹ / ₈	1 ⁵ / ₈	4 ¹ / ₈	7½	1 ¹ / ₈	8	1	6	5¾
3	10½	1 ⁷ / ₈	5	8	1¼	8	1 ¹ / ₈	6¾	6½
4	12¼	2 ¹ / ₈	6 ³ / ₁₆	9½	1 ³ / ₈	8	1¼	7½	7¼
5	14¾	2 ⁷ / ₈	7 ⁵ / ₁₆	11½	1 ⁵ / ₈	8	1½	9½	9¼
6	15½	3¼	8½	12½	1½	12	1 ³ / ₈	10	9¾
8	19	3 ⁵ / ₈	10 ⁵ / ₈	15½	1¾	12	1 ⁵ / ₈	11¼	11
10	23	4¼	12¾	19	2	12	1 ⁷ / ₈	13¼	13
12	26½	4 ⁷ / ₈	15	22½	2 ¹ / ₈	16	2	14¾	14½
14	29½	5¼	16¼	25	2 ³ / ₈	16	2¼	16	15¾
16	32½	5¾	18½	27¾	2 ⁵ / ₈	16	2½	17½	17¼
18	36	6 ³ / ₈	21	30½	2 ⁷ / ₈	16	2¾	19¼	19
20	38¾	7	23	32¾	3 ¹ / ₈	16	3	21	20¾
24	46	8	27¼	39	3 ⁵ / ₈	16	3½	24	23¾

The regular ¼-inch raised face of Class 900 and 1500 flanges is not included in the minimum flange thickness given above. The addition of any facing is beyond the outside edge of the flange.



CHOOSE W&O.

- We are there when you need us.
- North American footprint – 16 strategically located branches.
- 40 years as a reputable partner.
- Over \$45 Million in inventory.
- Automation experts with in-house design and fabrication.
- We represent top brands with the required certifications and registrations.
- Largest North American distributor of pipe, valves, fittings, and automation.
- Valve Services – ship checks and Engineered Solutions troubleshooting.
- Delivering new technologies and monitoring regulations to better serve our customers.

LOCATIONS

Alabama

Mobile
4766 Rangeline Rd.
Mobile, AL 36619
Tel: 251.433.2816
mobile.al@wosupply.com

California

San Diego
VAC
2390 Boswell Rd.
Ste. 100
Chula Vista, CA 91914
Tel: 619.656.7420
vac@wosupply.com

Long Beach
800 West 14th St.
Long Beach, CA 90813
Tel: 562.435.6359
longbeach.ca@wosupply.com

Florida

Jacksonville - Corp. Office
2677 Port Industrial Drive
Jacksonville, FL 32226
Tel: 904.354.3800
corporate@wosupply.com

Ft. Lauderdale
3333 S.W. 2nd Ave.
Ft. Lauderdale, FL 33315
Tel: 954.462.8008
ftlauderdale.fl@wosupply.com

Tampa

1902 B 43rd St. N.
Tampa, FL 33605
Tel: 813.248.4139
tampa.fl@wosupply.com

Louisiana

New Orleans
4800 River Road
Jefferson, LA 70121
Tel: 504.733.6350
neworleans.la@wosupply.com

Houma

101 Capital Blvd.
Houma, LA 70360
Tel: 985.772.7010
houma.la@wosupply.com

New Jersey

Linden
7 West Baltimore Ave.
Linden, NJ 07036
Tel: 908.486.5338
linden.nj@wosupply.com

Pennsylvania

Philadelphia
950 Henderson Blvd.
Folcroft, PA 19032
Tel: 610.586.8070
philadelphia.pa@wosupply.com

South Carolina

Charleston
1670 Drydock Ave Building #9
North Charleston, SC 29405
Tel: 843.747.6347
charleston.sc@wosupply.com

Texas

Houston
8000 Market Street
Ste. 220
Houston, TX 77029
Tel: 832.386.9300
houston.tx@wosupply.com

Virginia

Norfolk
5901 Thurston Ave.
Virginia Beach, VA 23455
Tel: 757.217.2800
norfolk.va@wosupply.com

Washington

Seattle
7745 1st Ave. S.
Seattle, WA 98106
Tel: 206.223.0584
seattle.wa@wosupply.com

Canada

Vancouver
590 Ebury Place,
Unit #102
Delta, BC V3M 6K7
Tel: 604.525.9505
vancouver.bc@wosupply.com

Halifax

133 Ilsley Avenue, Unit LM
Dartmouth, NS
B3B1S9
Tel: 902.481.7333
halifax@wosupply.com



wosupply.com

July 2015